

➤ Waukesha Cherry-Burrell®

# UNIVERSAL® INDUSTRIAL SERIES

**U2 ND, 5000 and 420/520**  
External Circumferential Piston Pumps

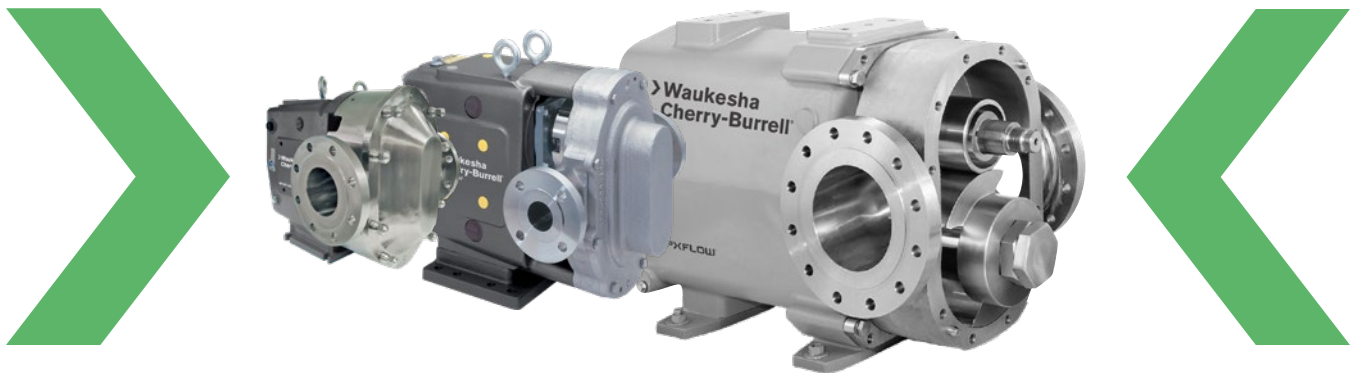

**SPXFLOW®**

# UNIQUELY DESIGNED AND ENGINEERED SPECIFICALLY FOR THE INDUSTRIAL MARKET

Waukesha Cherry-Burrell (WCB) has been the leader in the design, manufacturing and application of external circumferential piston (ECP) style, rotary positive displacement (PD) pumps. The Universal Series offers tremendous installation flexibility with capabilities including bi-directional flow, three-way universal gear case mounting, and upper or lower shaft positioning. Heavy-duty features and construction ensure long life in the most demanding applications. Pressure ratings up to 500 psi (34.5 bar), 300°F (149°C) and clean-in-place (CIP) capabilities have earned the Universal 2 ND series pump a solid reputation as a proven performer in the industry.

## Key Performance Features and Benefits

- Pumps filled with settled slurries will start without damaging pump or seals
- Will not damage shear sensitive products
- Pulsation free flow leads to lower vibration and wear to the system
- No internal rotor contact leading to longer life
- Shaft timing not critical for ease of maintenance
- No oil seepage into product zone eliminates contamination concerns

## Installation Features and Benefits

- Bi-directional flow. Rotors, locked with unique washers and torqued nuts, rotate securely in either direction
- Interchangeable installation dimensions with Universal 1 and Universal Lobe PD Series pumps
- Versatile three-way mounting of gear case, including vertical alignment of ports
- Upper or lower drive shaft position



**U2 ND Pumps**

1" to 6" (25 to 152 mm) for pressures up to 500 psi (34.5 bar)  
WCB-Designed Seals



**5000 Pumps**

1.5" to 6" (38 to 152 mm) for pressures up to 200 psi (13.8 bar)  
Third-Party Seals Options Only



**420/520 UHC Pumps**

6" to 8" (152 to 203 mm) for pressures up to 200 psi (13.8 bar)  
High-volume capacities up to 830 GPM (187 m<sup>3</sup>/hr)

# LONG LIFE FEATURES AND BENEFITS

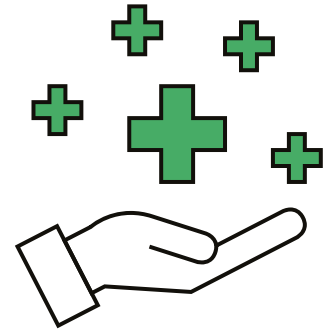

## The Standard of Performance and Reliability for More than a Quarter Century

For more than half a century, WCB has been a leader in the design, manufacture and application of ECP rotary PD pumps. WCB PD pumps are in thousands of challenging chemical and industrial applications.

+	Waukesha 88 Alloy Rotors- high Nickel content alloy with non-galling feature which allows for tight tolerances of the rotor to pump body
+	316 stainless steel pump body and cover helps minimize corrosion
+	Pumps with water flush seals will run dry indefinitely with water
+	Up to 500 psi (34.5 bar) pressure capability
+	No bearing in product zone minimizes wear and corrosion risk
+	Larger diameter 17-4 PH stainless steel shafts in seal area for greater strength and stiffness. Helps eliminate vibration; extends seal life on all models
+	Heavy-duty bearing frame ensures shaft alignment for longer life
+	Double-tapered roller bearings on all models. Contribute further to precise rotor position and longer seal life
+	Grease lubed bearings for positive lubrication to all bearings over entire speed, temperature and pressure range
+	Operates up to 300°F (149°C) capacity upon application
+	Various mechanical seal options available to optimize life and performance
+	CIP capable design helps minimize corrosion

# PERFORMANCE AND LONG LIFE THROUGH ENGINEERING

## U2 ND

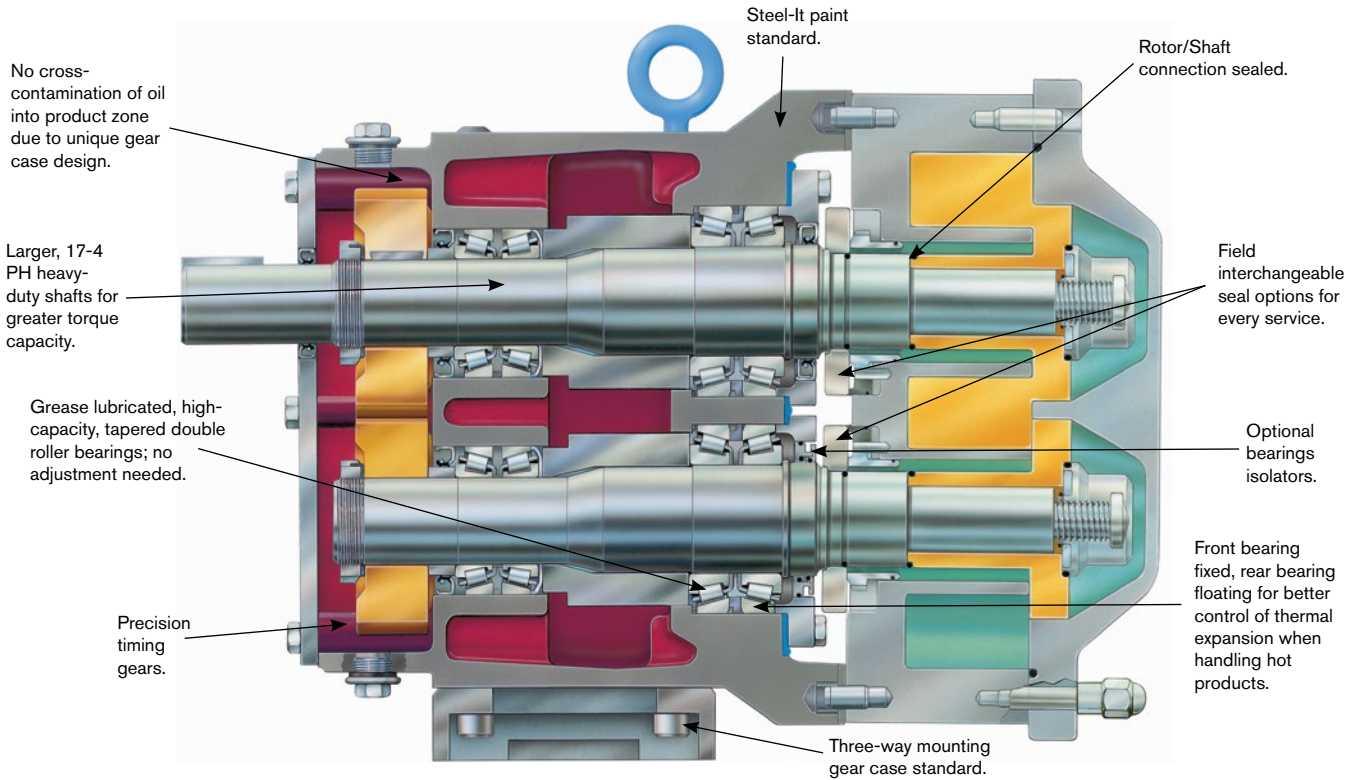

## U2 ND SERIES SEAL OPTIONS

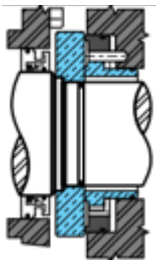

### Double Concentric Mechanical Seal\*

Used with flushing fluid to cool, lubricate, flush away residue. Best arrangement for severe service. Low pressure and high pressure flush double seals available.

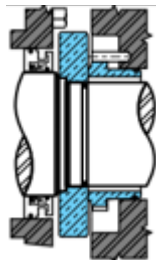

### Single Mechanical Seal\*

Carbon-to-ceramic faces standard. Alternate materials available for abrasive service. Standard and knife edge internal seal faces available.

## 5000 SERIES

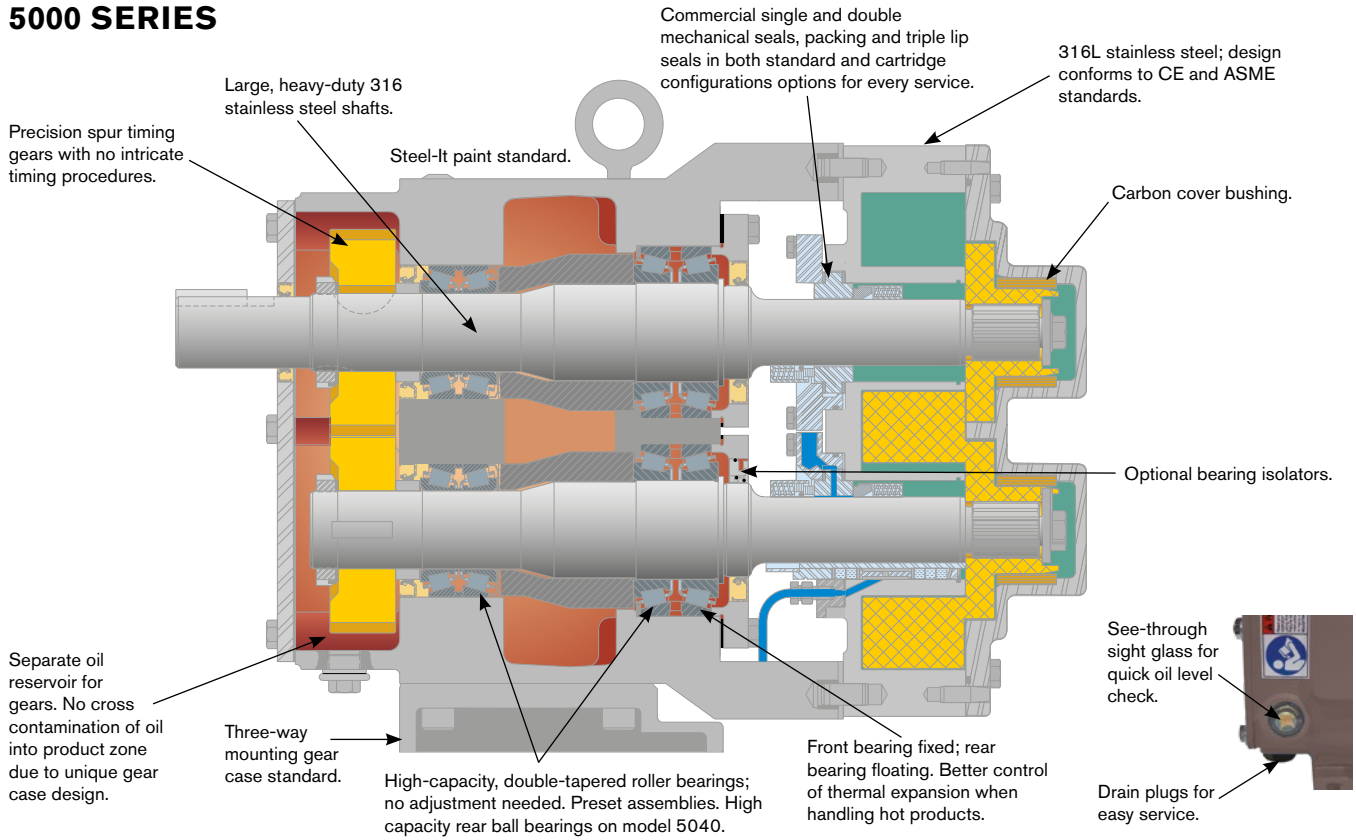

## 5000 SERIES SEAL OPTIONS

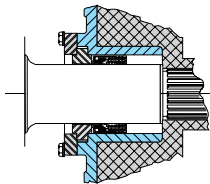

**Single Inner Mechanical Seal**

J. Crane Type 9 with carbon and ceramic seal faces standard. Narrow face seal with TC and SC seal faces as option. Consult factory.

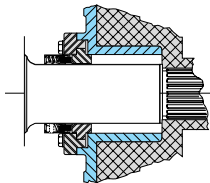

**Single Outer Mechanical Seal**

J. Crane Type 8B2 with carbon and ceramic seal faces standard.

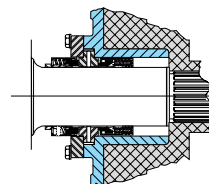

**Double Mechanical Seal**

Used with flushing fluid to cool, lubricate, flush away residue. Best arrangement for severe service. Combines above single inner and outer seals.

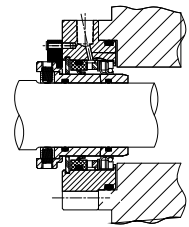

**Triple Lip Seal**

Available in Cartridge design. Consult factory.

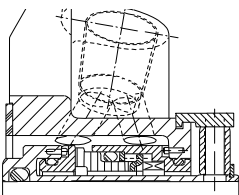

**Cartridge Seals**

Consult factory for availability. See instruction manual 95-03012 for stuffing box dimensions.

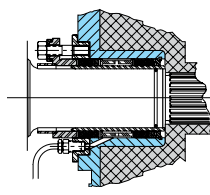

**Packing**

J. Crane Style 1335 TFE impregnated braided acrylic with stainless steel sleeve standard.

**Elastomer choices for O-rings:**  
Buna-N, Fluoroelastomer (FKM), EPDM, Silicone, Perfluoroelastomer (FFKM), PTFE Encapsulated

**Mechanical seal material options:**  
Carbon, Ceramic, Silicon Carbide, Tungsten Carbide

# TIME-TESTED WCB ROTARY PUMP; ECP OPERATING PRINCIPLE

## Theory of Operation

In the WCB design, arc-shaped “pistons” (rotor wings) travel in annular shaped cylinders machined in the pump body; the resulting long sealing path reduces slippage and produces a smooth flow of product without destructive pulses or pressure peaks and without valves or complex parts.

## For Low Viscosity Fluids

Rotors, made of exclusive Waukesha Alloy 88, can be run with close clearance to the 316 stainless steel fluid head, without galling or seizing should inadvertent pressure surges cause contact. The close clearances combined with the rotor geometry, which gives a long sealing path between the pump inlet and outlet, means low slip operation. As a result, you achieve: high volumetric efficiency and good flow control.

## For High Viscosity Fluids

The large fluid cavities of the rotors plus the large, easy entry anti-cavitation ports, allow efficient pumping of high viscosity fluids, slurries or even liquids with large chunks or particles.

## For Non-Lubricating and Abrasive Fluids

The unique WCB design has no bearings in the fluid being pumped, no sliding or rolling contact and no rotor-to-rotor contact. This produces MAXIMUM SERVICE LIFE even under severe operating conditions.

## Resuspending Solids/Slurries

When slurries settle to the bottom of lobe or progressive cavity pumps, many will jam the pump upon restart. The unique shape of the Waukesha rotor will resuspend the slurry easily and with hardly a pulse.

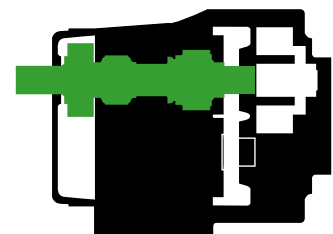
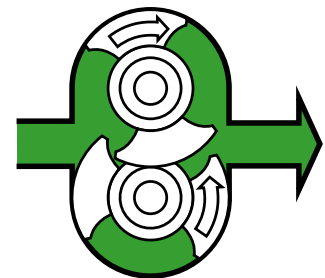
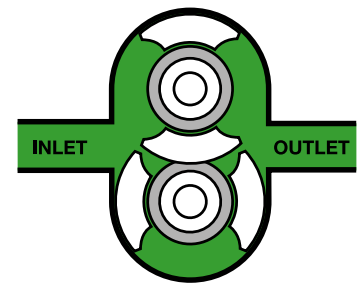
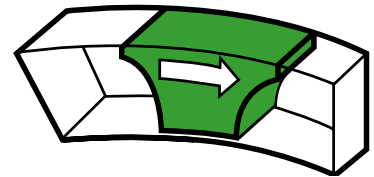

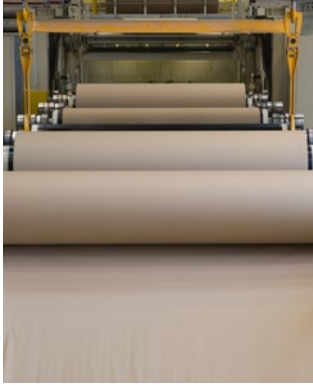

## Typical Product Applications

- Acids
- Adhesives
- Alkalines
- Coatings
- Corn Wet Milling
- Defoamers
- Detergents
- Emulsions
- Glue
- Grease
- Ink
- Lacquer
- Latex
- Oils & Lubricants
- Paints
- Paper Coatings
- Polymers
- Pulp & Paper Slurry
- Resins
- Retention Aids
- Sealants
- Silicone Emulsions
- Sludges
- Slurries
- Soaps
- Solvents
- Specialty Chemicals
- Starch

## PRODUCT DIMENSIONS

# NEW LEVELS OF PERFORMANCE

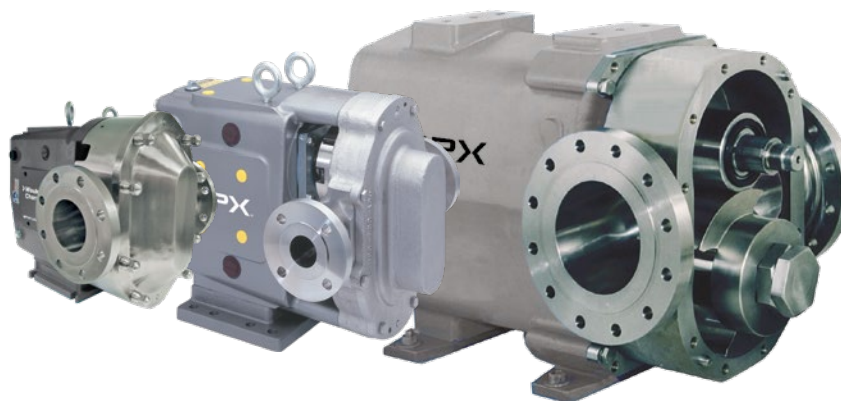

The series covers a range of nominal flow rates from 2 to 830 GPM (0.5 to 189 m<sup>3</sup>/hr).

MODEL	DISPLACEMENT PER REVOLUTION		NORMAL CAPACITY TO		INLET/OUTLET		PRESSURE RANGE**		MAXIMUM RPM***	APPLICABLE WEIGHTS	
	GAL.	LITER	GPM	M <sup>3</sup> /HR	IN	MM	PSI	BAR		LBS	KGS
U2 ND-006	.0082	.031	8	1.8	1"	25	300	20.7	1000	55	25
U2 ND-015	.014	.054	11	2.5	1.5"	38	250	17.2	800	60	27
U2 ND-018	.029	.110	20	4.5	1.5"	38	200	13.8	700	60	27
U2 ND-030	.060	.227	36	8.2	1.5"	38	250	17.2	600	120	54
U2 ND-040	.076	.228	46	10.4	2"	51	150	10.50	600	120	54
U2 ND-045	.098	.371	58	13.2	2"	51	450	31.0	600	120	54
U2 ND-060	.153	.579	90	20.4	2.5"	64	300	20.7	600	270	122
U2 ND-130	.253	.958	150	34.1	3"	76	200	13.8	600	300	136
U2 ND-180	.380	1.438	230	52.2	3"	76	450	31.0	600	505	229
U2 ND-210	.502	1.900	300	68.1	4"	102	500	34.5	600	505	229
U2 ND-220	.521	1.972	310	70.4	4"	102	300	20.7	600	505	229
U2 ND-320	.752	2.847	450	102	6"	152	300	20.7	600	850	386
U2 ND-370	1.099	4.160	660	150	6"	152	200	13.8	600	1000	454
420 UHC	1.619	6.13	648	147	6"	152	200	13.8	400	2595	1177
520 UHC	2.375	8.99	830	187	8"	203	150	10.3	350	2905	1317
5040	.060	0.227	36	8.2	1.5"	38	200	13.8	600	135	61
5050	.153	0.579	90	20.4	2"	51	200	13.8	600	275	125
5060	.254	0.961	150	34.1	2.5"	64	200	13.8	600	285	129
5070	.440	1.666	260	59.1	4"	102	200	13.8	600	575	261
5080	.754	2.854	450	102	6"	152	200	13.8	600	940	426

Temperature Range for all models ranges from -40°F/C to 300°F (149°C)

\* Optional Inlet and Outlet available for 5040 2", 5050 2.5" and 5060 3"

\*\* Contact Application Engineering for higher pressure or higher temperature applications

\*\*\* Actual Max RPM is fluid dependent based on testing at SPX FLOW Test Lab



## PRODUCT DIMENSIONS

### U2 ND

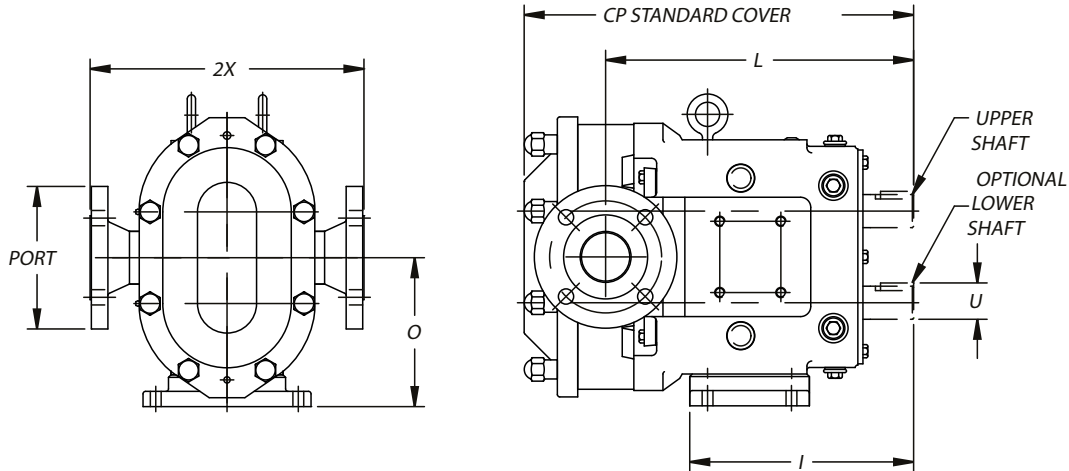

MODEL		CP	I	L	O	PORT SIZE	U +.000 -.001	2X	CP4	APPLICABLE WEIGHTS	
										LBS	KGS
006-U2 ND	in	11.71	7.66	9.61	4.21	1"	.875	6.97	14.92	55	25
	mm	297	194	244	107	--	22.23	177	379	60	27
015-U2 ND	in	11.71	7.66	9.61	4.21	1-1/2"	.875	6.97	14.92	60	27
	mm	297	194	244	107	--	22.23	177	379	120	54
018-U2 ND	in	12.37	7.66	10.48	4.21	1-1/2"	.875	6.97	15.58	120	54
	mm	314	194	266	107	--	22.23	177	396	120	54
030-U2 ND	in	14.49	8.83	11.61	5.21	1-1/2"	1.250	8.50	17.58	270	122
	mm	368	224	295	132	--	31.75	216	447	300	136
040-U2 ND	in	14.87	8.83	11.77	5.21	2"	1.25	8.62	14.87	505	229
	mm	378	224	305	132	-----	31.75	219	378	505	229
045-U2 ND	in	18.59	10.99	14.86	7.31	2"	1.625	10.75	22.28	505	229
	mm	472	279	377	186	--	41.28	273	566	850	386
060-U2 ND	in	19.14	10.99	15.14	7.31	2-1/2"	1.625	10.75	22.83	1000	454
	mm	486	279	385	186	--	41.28	273	580	55	25
130-U2 ND	in	20.15	10.99	15.77	7.312	3"	1.625	10.75	23.84	60	27
	mm	512	279	401	186	--	41.28	276	606	60	27
180-U2 ND	in	23.26	14.80	18.25	9.38	3"	2.000	13.06	28.51	120	54
	mm	591	376	464	238	--	50.80	332	724	120	54
210-U2 ND	in	27.08	17.80	21.24	10.38	4"	2.375	14.73	27.08	120	54
	mm	688	452	539	264	-----	60.45	374	688	270	122
220-U2 ND	in	24.00	14.80	18.49	9.38	4"	2.000	13.25	29.25	300	136
	mm	610	376	470	238	--	50.80	337	743	505	229
320-U2 ND	in	27.66	17.80	21.63	10.38	6 150# FLG	2.375	16.00	27.66	505	229
	mm	703	452	549	264	--	60.45	406	703	505	229
370-U2 ND	in	29.16	17.80	22.32	10.38	6 150# FLG	2.38	17.00	29.16	850	386
	mm	741	452	567	264	---	60.5	432	741	1000	454

\* Listed capacity and maximum rpm for intermittent duty only.  
Consult WCB technical services for recommendations on your pumping requirements.

## PRODUCT DIMENSIONS

### 420/520 UHC

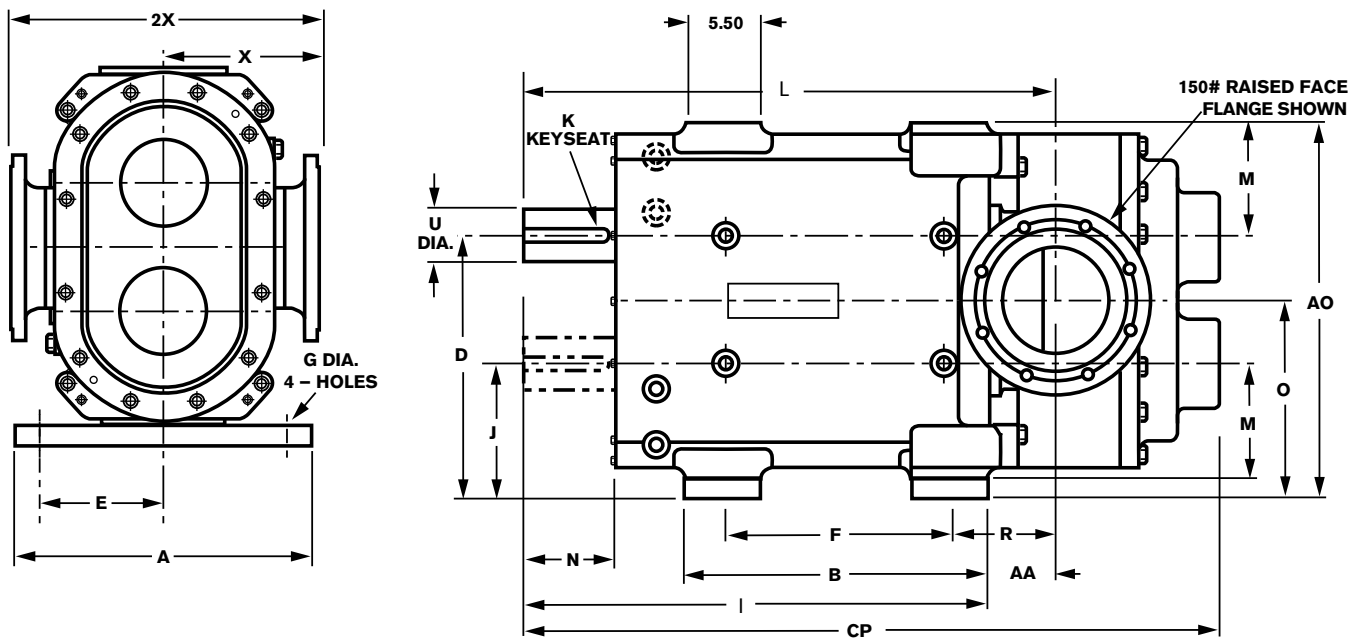

MODEL		A	AA	AO	B	CP	D	E	F	G	I	APPLICABLE WEIGHTS	
												LBS	KGS
420-UHC	in	21.00	5.60	27.25	22.00	49.60	18.75	9.00	16.50	1.06	33.60	2595	1177
	mm	533	142	692	559	1260	476	229	419	27	853		
520-UHC	in	21.00	5.95	27.25	22.00	51.47	18.75	9.00	16.50	1.06	33.60	2905	1317
	mm	533	151	692	559	1307	476	229	419	27	853		

MODEL		J	K	L	M	N	O	R	U	X	2X	FLANGE SIZE
	mm	248	25	995	216	153	362	212	98	286	572	152
520-UHC	in	9.75	1.00	39.55	8.50	6.04	14.25	8.70	3.875	11.25	22.50	ANSI 8"
	mm	248	25	1005	216	153	362	221	98	286	572	203

## 5000 SERIES

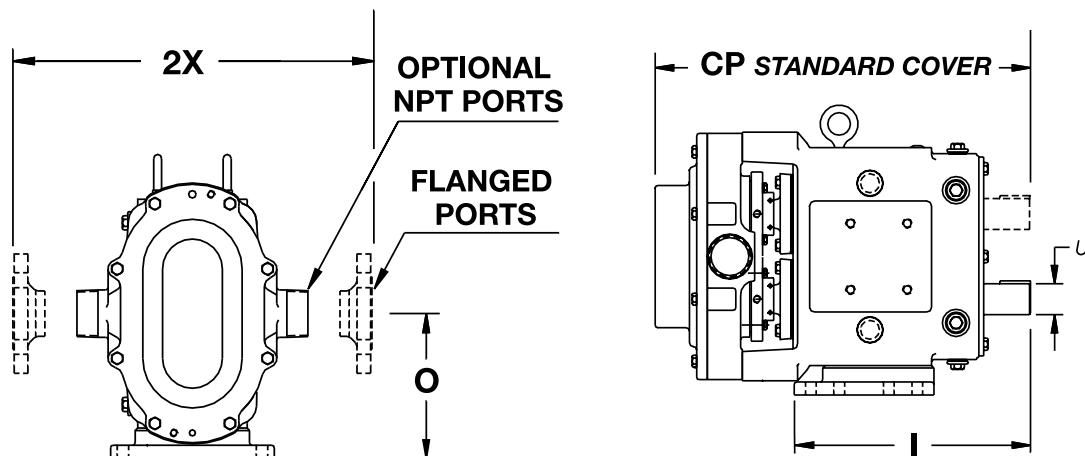

MODEL		CP	I	O	PORT SIZE	U +.000 -.001	2X	APPLICABLE WEIGHTS	
								LBS	KGS
5040	in	16.52	8.83	5.21	1-1/2" - 150# Flange	1.250	11.91	100	45
	mm	419	224	132	--	31.75	303		
5050	in	19.83	12.49	7.31	2" - 150# Flange	1.625	13.25	240	109
	mm	504	317	186	--	41.28	337		
5060	in	20.78	12.49	7.31	2-1/2" - 150# Flange	1.625	13.50	245	111
	mm	528	317	186	--	41.28	343		
5070	in	26.31	15.29	9.38	4" - 150# Flange	2.000	14.75	475	215
	mm	668	388	238	--	50.80	375		
5080	in	30.17	17.80	10.38	6" - 150# Flange	2.375	16.00	810	367
	mm	766	452	264	--	60.33	406		

# Waukesha Cherry-Burrell®

## DRIVE OPTION

Close coupled Tru-Fit® pump mounted on epoxy-painted base.

### Features

No shaft alignment necessary. No coupling guard required

Reduces overall length of complete unit by an average of 20-25%

Average of 20-25 gear ratios available per horsepower

Separate oil sump for gear reducer and timing gears

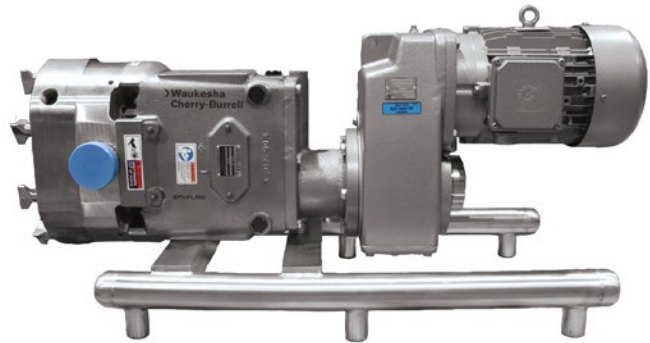

### Options

- NEMA or IEC frame motors available. Right angle reducer also available for additional space savings
- 1/2 through 60 horsepower drive options available
- Horizontal or vertical porting

# SPXFLOW®

SPX FLOW, Inc. reserves the right to incorporate our latest design and material changes without notice or obligation. Design features, materials of construction and dimensional data, as described in this bulletin, are provided for your information only and should not be relied upon unless confirmed in writing. Please contact your local sales representative for product availability in your region. The green ">" is a trademark of SPX FLOW, Inc.

For more information, visit [www.spxflow.com](http://www.spxflow.com).

©2024 SPX FLOW, Inc.  
WCB\_U2-ND\_BRO\_US