

Universal TS Series

ROTARY POSITIVE DISPLACEMENT TWIN SCREW PUMP

FORM NO.: 95-03141
REVISION: 07/2023

READ AND UNDERSTAND THIS MANUAL PRIOR TO OPERATING OR SERVICING THIS PRODUCT.



Waukesha Cherry-Burrell®



PRODUCT INFORMATION AT YOUR FINGERTIPS

eXpress App

With the new eXpress app, accessing information on a SPX FLOW product is quick and easy.

Simply scan a serial number or QR code and:

- Watch product videos
- Download manuals and drawings
- Receive faster responses to inquiries
- Quick access to where to buy
- Register customer equipment

Scan and Download the eXpress App today



iOS



Android

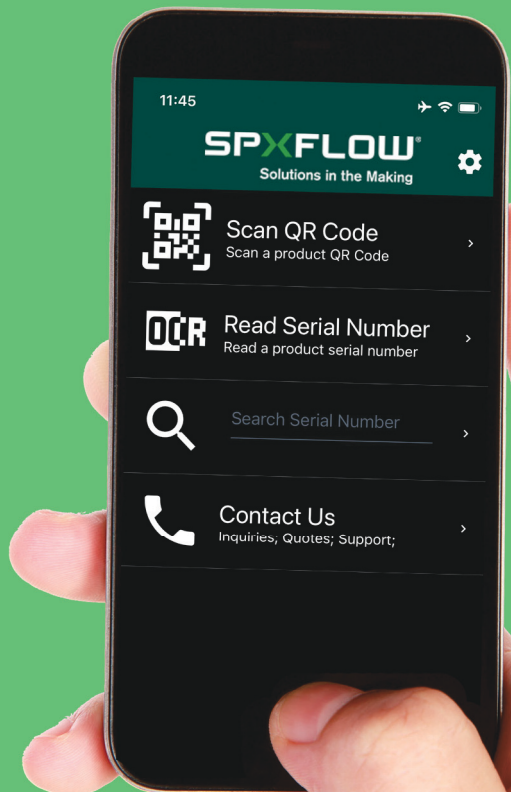

Connect with SPX FLOW    



Declaration of Conformity for Pumps

SPX Flow US, LLC, 611 Sugar Creek Drive, Delavan, WI 53120, USA
herewith declares that the

pumps of the series

Universal TS

UTS 015, UTS 030, UTS 130, UTS 220

meet the requirements of the Directives 2006/42/EC (superseding 89/392/EEC and 98/37/EC) and ProdSG (superseding GPSG - 9.GPSGV).

For official inspections, SPX Flow Technology Rosista GmbH presents a technical documentation according to Appendix VII of the Machinery Directive, this documentation consisting of documents of the development and construction, description of measures taken to meet the conformity and to correspond with the basic requirements on safety and health, include an analysis of the risks, as well as an operating manual with safety instructions.

The conformity of the pumps is guaranteed.

Authorised person for the documentation:
SPX Flow Technology Rosista GmbH, Frank Baumbach,
Gottlieb-Daimler-Str. 13, D-59439 Holzwickede

May 17, 2017



Regional Eng Mgr, F&B Components

**> Waukesha
Cherry-Burrell®**

CERTIFICATE OF COMPLIANCE



Valid until end: December, 2018

TUM Certification
hereby declares that the product

twin screw pump series UTS, size 015 to 220 with EPDM, FKM or FFKM gaskets
and SiC, TC or C mechanical seal material

from

SPX Flow, Inc., Delavan, WI 53115, USA

has been evaluated for compliance with the
Hygienic Equipment Design Criteria of the EHEDG, by:

TUM (Forschungszentrum für Brau- u. Lebensmittelqualität) at Weihenstephan, Germany
and meets the criteria as demonstrated by:

Evaluation Report No. 577TUM2017

Signed Jürgen Hofmann
Dr. Jürgen Hofmann

Evaluation Officer

Signed Fritz Jakob
Prof. Dr. Fritz Jakob

Head of Department

Date of issue: 28 November 2017

Certificate No. 18/2017



85354 Freising-Weihenstephan, Germany
©EHEDG

SPX FLOW, Inc.
611 Sugar Creek Road
Delavan, WI 53115 USA

Tel: (800) 252-5200 or (262) 728-1900
Fax: (800) 252-5012 or (262) 728-4904

E-mail: wcb@spxflow.com
Web site: www.spxflow.com

Information contained in this manual is subject to change without notice and does not represent a commitment on the part of SPX FLOW, Inc.. No part of this manual may be reproduced or transmitted in any form or by any means, electronic or mechanical, including photocopying and recording, for any purpose, without the express written permission of SPX FLOW, Inc..

Copyright © 2022 SPX FLOW, Inc.
All Rights Reserved.

Loctite® is a registered trademark of Henkel Corporation

Revision Date: 07/2023

Publication: 95-03141



TRIPLEX
Sales Company

Warranty	9
Shipping Damage or Loss	9
Warranty Claim	9
Safety	10
Warnings	11
Replacement Labels	12
Care of Component Materials	13
Stainless Steel Corrosion	13
Alloy 88	13
Aluminum	13
Elastomer Seal Replacement Following Passivation	13
Introduction	13
Pump Receiving	13
Intended Use	13
Equipment Serial Number	13
Certifications	14
Operating Parameters	14
Qualification Guidelines for Operating Staff	15
Installation	16
Important Safety Information	16
Lifting	16
Install Pump and Drive Unit	18
Direction of flow	19
Install Connections and Piping	19
Install Check Valves	20
Install Isolation Valves	21
Install Relief Valves	21
Inlet Side Strainers and Traps	22
Install Pressure Gauges	22
Seal Flush Connections	22
CIP (Clean-In-Place) Features	23
Check Angular Alignment	23
Check Coupling Alignment	24
Check Parallel Alignment	24
Check Belt and Chain Drive Alignment	24
Operation	25
Important Safety Information	25
Pre-Startup Checklist	25
Starting the Pump	26
Stopping the Pump	26
Maintenance	27
Important Safety Information	27
Lubrication	28
Oil Specification	28
Maintenance Inspections	28
Maintenance Inspection Chart	29
Annual Maintenance	30
Cleaning	31
Fluid Head Disassembly	32
Remove cover	32
Remove screw nuts - All models except 220-UTS	33



Remove screw nuts - 220-UTS only	34
Remove screws	35
Remove seal cap and seal	36
Removing seal without removing body	37
Remove pump body	38
Double seal - remove seals	39
Single and double seal - remove seal carrier	40
Removing seal after body is removed	40
Remove Pump Body-Center, 3 Piece UTS030 and UTS130	41
Remove Pump Body-Ported, 3 Piece UTS030 and UTS130	42
Fluid Head Assembly	43
Seal assembly	43
Installing seals before installing body	44
Install pump body	48
Installing seals after the body is installed	51
Seal cap assembly	52
Install screws	54
Screw nut assembly	56
Installing screw nuts - all models except 220-UTS	58
Installing screw nuts - 220-UTS only	59
Install cover	60
Install Pump Body-Ported, 3 Piece UTS030 and UTS130	62
Install Pump Body-Center, 3 Piece UTS030 and UTS130	65
Gear Case Disassembly	66
Remove oil drain plugs and cover	66
Remove gear from short shaft	67
Remove gear from drive shaft	68
Remove shaft	68
Shaft disassembly	69
Gear Case Assembly	70
Shaft assembly	70
Install shafts in gear case	79
Install Bearing Retainers	82
Install Gears and Time Screws	84
Install gear on drive shaft	85
Install plugs, sight glass, eye bolts	87
Install gear on short shaft	88
Timing	89
Assemble and install gear case cover	93
Gear Case Disassembly Of UTS PLUS	96
Remove oil drain plugs and cover	96
Remove gear from short shaft	97
Remove gear from drive shaft	98
Remove shaft	99
Shaft disassembly	101
Gear Case Assembly Of UTS PLUS	102
Shaft assembly	102
Troubleshooting	119
Pump Dimensions	123
Universal Twin Screw PD Pump Dimensions	123
Pump Shaft Guards	124
Long Term Storage	125
Parts List	127
015-UTS Parts	127
030-UTS Parts	131



130-UTS Parts	135
220-UTS Parts	139
030-UTS Pump Body-Centre, 3 Piece Parts	143
030-UTS PLUS Parts, continued	145
130-UTS Pump Body-Centre, 3 Piece Parts	147
130-UTS PLUS Parts, continued	149
Universal Twin Screw Seal Parts	152
Universal Twin Screw Seal Kits	153
Special Tools	154
Universal Twin Screw Maintenance Summary Reference Sheet	155
Universal Twin Screw Maintenance Summary Reference Sheet - Copy for optional removal	156



Warranty

LIMITED WARRANTY: Unless otherwise mutually agreed to in writing, (a) SPX FLOW US, LLC (SPX FLOW) goods, auxiliaries and parts thereof are warranted to the Buyer against defective workmanship and material for a period of twelve (12) months from date of installation or eighteen (18) months from date of delivery, whichever expires first, and (b) SPX FLOW services are warranted to Buyer to have been performed in a workman-like manner for a period of ninety (90) days from the date of performance. If the goods or services do not conform to the warranty stated above, then as Buyer's sole remedy, SPX FLOW shall, at SPX FLOW's option, either repair or replace the defective goods or re-perform defective services. If Buyer makes a warranty claim to SPX FLOW and no actual defect is subsequently found, Buyer shall reimburse SPX FLOW for all reasonable costs which SPX FLOW incurs in connection with the alleged defect. Third party goods furnished by SPX FLOW will be repaired or replaced as Buyer's sole remedy, but only to the extent provided in and honored by the original manufacturer's warranty. Unless otherwise agreed to in writing, SPX FLOW shall not be liable for breach of warranty or otherwise in any manner whatsoever for: (i) normal wear and tear; (ii) corrosion, abrasion or erosion; (iii) any good or services which, following delivery or performance by SPX FLOW, has been subjected to accident, abuse, misapplication, improper repair, alteration (including modifications or repairs by Buyer, the end customer or third parties other than SPX FLOW), improper installation or maintenance, neglect, or excessive operating conditions; (iv) defects resulting from Buyer's specifications or designs or those of Buyer's contractors or subcontractors other than SPX FLOW; or (v) defects resulting from the manufacture, distribution, promotion or sale of Buyer's products; (vi) damage resulting from the combination, operation or use with equipment, products, hardware, software, firmware, systems or data not provided by SPX FLOW, if such damage or harm would have been avoided in the absence of such combination, operation or use; or (vii) Buyer's use of the goods in any manner inconsistent with SPX FLOW's written materials regarding the use of such product. In addition, the foregoing warranty shall not include any labor, dismantling, re-installation, transportation or access costs, or other expense associated with the repair or replacement of SPX FLOW goods. THE WARRANTIES CONTAINED HEREIN ARE THE SOLE AND EXCLUSIVE WARRANTIES AVAILABLE TO BUYER AND SPX FLOW HEREBY DISCLAIMS ANY OTHER WARRANTIES, EXPRESS OR IMPLIED, INCLUDING WITHOUT LIMITATION THE IMPLIED WARRANTIES OF MERCHANTABILITY AND FITNESS FOR A PARTICULAR PURPOSE, ANY PERFORMANCE OR PROCESS OUTCOME DESIRED BY THE BUYER AND NOT SPECIFICALLY AGREED TO BY SPX FLOW. THE FOREGOING REPAIR, REPLACEMENT AND REPERFORMANCE OBLIGATIONS STATE SPX FLOW'S ENTIRE AND EXCLUSIVE LIABILITY AND BUYER'S EXCLUSIVE REMEDY FOR ANY CLAIM IN CONNECTION WITH THE SALE AND FURNISHING OF SERVICES, GOODS OR PARTS, THEIR DESIGN, SUITABILITY FOR USE, INSTALLATION OR OPERATIONS.

Shipping Damage or Loss

If equipment is damaged or lost in transit, file a claim at once with the delivering carrier. The carrier has a signed Bill of Lading acknowledging that the shipment has been received from SPX FLOW in good condition. SPX FLOW is not responsible for the collection of claims or replacement of materials due to transit shortage or damages.

Warranty Claim

Warranty claims must have a **Returned Material Authorization (RMA)** from the Seller or returns will not be accepted. Contact 800-252-5200 or 262-728-1900.

Claims for shortages or other errors must be made in writing to Seller within ten (10) days after delivery. This does not include transit shortage or damages. Failure to give such notice shall constitute acceptance and waiver of all such claims by Buyer.



Safety

READ AND UNDERSTAND THIS MANUAL PRIOR TO INSTALLING, OPERATING, OR SERVICING THIS EQUIPMENT

SPX FLOW recommends users of our equipment and designs follow the latest Industrial Safety Standards. At a minimum, these should include the industrial safety requirements established by:

1. Occupational Safety and Health Administration (OSHA)
2. National Fire Protection Association (NFPA)
3. National Electrical Code (NEC)
4. American National Standards Institute (ANSI)

⚠ WARNING

Severe injury or death can result from electrical shock, burn, or unintended actuation of equipment. Recommended practice is to disconnect and lockout industrial equipment from power sources, and release stored energy, if present. Refer to the National Fire Protection Association Standard No. NFPA70E, Part II and (as applicable) OSHA rules for Control of Hazardous Energy Sources (Lockout-Tagout) and OSHA Electrical Safety Related Work Practices, including procedural requirements for:

- Lockout-tagout
- Personnel qualifications and training requirements
- When it is not feasible to de-energize and lockout-tagout electrical circuits and equipment before working on or near exposed circuit parts

Before putting SPX FLOW equipment into operation, the operator shall analyze the application for all foreseeable risks, their likelihood to occur and the potential consequences of the identified risks as per ISO 31000 and ISO/IEC 31010 in their actual current version.

Locking and Interlocking Devices: These devices should be checked for proper working condition and capability of performing their intended functions. Make replacements only with the original equipment manufacturer's OEM renewal parts or kits. Adjust or repair in accordance with the manufacturer's instructions.

Periodic Inspection: Equipment should be inspected periodically. Inspection intervals should be based on environmental and operating conditions and adjusted as indicated by experience. At a minimum, an initial inspection within 3 to 4 months after installation is recommended. Inspection of the electrical control systems should meet the recommendations as specified in the National Electrical Manufacturers Association (NEMA) Standard No. ICS 1.3, Preventative Maintenance of Industrial Control and Systems Equipment, for the general guidelines for setting-up a periodic maintenance program.

Replacement Equipment: Use only replacement parts and devices recommended by the manufacturer to maintain the integrity of the equipment. Make sure the parts are properly matched to the equipment series, model, serial number, and revision level of the equipment.

Warnings and cautions are provided in this manual to help avoid serious injury and/or possible damage to equipment:

⚠ DANGER

Immediate hazards which WILL result in severe personal injury or death.

⚠ WARNING

Hazards or unsafe practices which COULD result in severe personal injury or death.

⚠ CAUTION

Hazards or unsafe practices which COULD result in minor personal injury or product or property damage.

Warnings

1. Read the instructions before installing the pump and starting it up. Always follow the guidelines for assembly in order to achieve optimum operational reliability.
2. Always check that the specifications of the motor and the motor control unit are correct, particularly in operating environments where there may be a risk of explosion.
3. Pumps should only be installed, disassembled, repaired and assembled by personnel trained in servicing pumps.
4. Always ensure that all electrical installation is carried out by qualified staff.
5. Never hose down or clean the electric motor directly with water or cleaning fluid. If the motor will be used in a washdown environment, a washdown designed motor must be used.
6. Never dismantle the pump before the motor has been disconnected from the power supply. Remove the fuses and disconnect the cable from the motor terminal box.
7. Never dismantle the pump until the isolating valves on the suction and discharge side have been closed and the immediate pipe system has been drained. If the pump is used for hot and/or hazardous fluids, special precautions must be taken. In such cases follow the local regulations for personal safety when working with these products.
8. Always ensure that all pipe connections have been fitted and tightened properly before the pump is started. If the pump is used for hot and/or hazardous liquids, take special care: follow the local regulations for personal safety when working with these products.
9. Always wear personal protective equipment according to the requirements established by OSHA, NFPA, NEC (See page 10).
10. Always remove all assembly and auxiliary tools from the pump before starting it up.
11. Make sure product lines and power cables are laid in suitable guides/trays.
12. Always ensure that no debris of any kind is present in the pump.
13. Always ensure that the pump and the motor shafts are properly aligned.
14. Always ensure that the suction and discharge valves isolating the pump are fully open before starting the pump.
15. Never close or obstruct the outlet of the pump as the pressure in the system will increase above the specified maximum pressure of the pump and cause damage to the pump.
16. There are rotating parts in the pump. Never put hands or fingers into a pump while it is in operation.
17. The pump components and piping may contain sharp edges. Handle the screws carefully because edges may be sharp. Wear gloves while installing and servicing the pump to help avoid injuries from these hazards.
18. Never touch the gear case during operation. The surface temperature of the gear case can get above 160°F (71°C) when running at 1000-3500 RPM. The pump cover and body may be cold or hot depending on the product (CIP at 190°F (88°C) or 300°F (149°C) product, for example).
19. Never touch the motor or motor shroud (if supplied) during operation, as it can become very hot.
20. When moving the pump, use appropriate lifting devices. Attach lifting devices to the eye bolts on the gear case; the gear case has holes for attaching lifting eye bolts. The 130 and 220 UTS pumps have a third lifting point on the body (130) and cover (220). Always use securely fitted lifting straps when lifting with a crane or similar lifting gear. See “Lifting” on page 16.
21. Never drop parts on the floor.
22. Never exceed the maximum temperature specified under “Operating Parameters” on page 14.
23. Never exceed 375 psi / 25.8 bar maximum operating pressure.
24. Guards should be used when applicable. See page 18 and page 25.
25. Make sure to keep the work area clear of machine parts, tools, product lines, foreign materials, and power cables to avoid potential hazards.



Replacement Labels

⚠️ WARNING

The following labels are installed on your equipment. If these labels are removed or become unreadable, contact SPX FLOW customer service at 800-252-5200 or 262-728-1900, and refer to the part numbers below.

Application Instructions

Apply to a clean, dry surface. Remove the backing from the label, place it in proper position, protect it with a cover sheet and burnish it. (A soft rubber roller also may be used to press the label into place.) Apply all labels to be readable from the front of the pump.

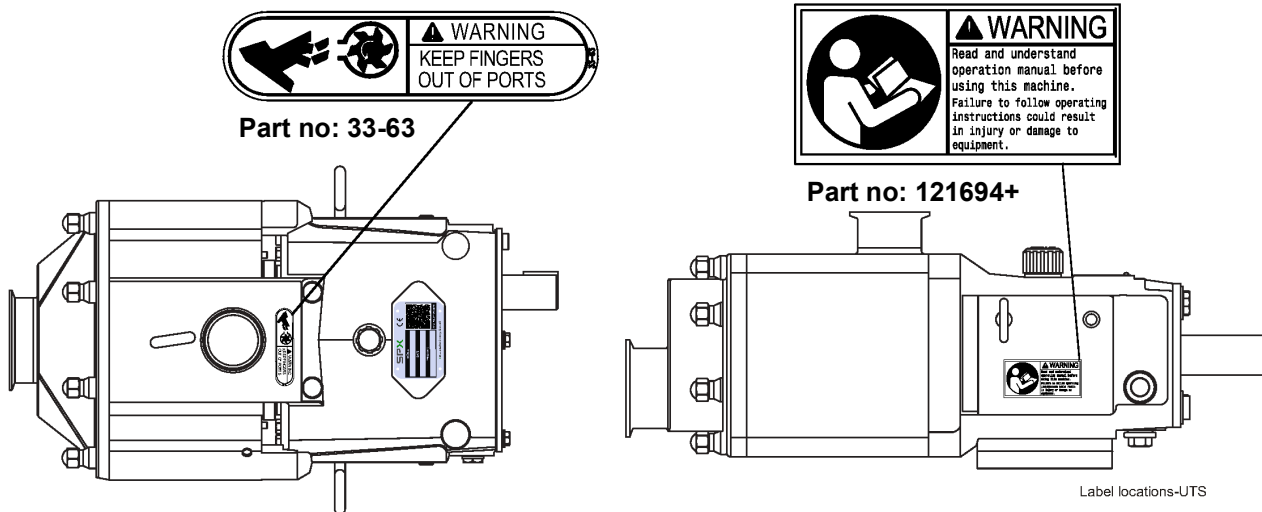

The labels above are affixed to the pumps as shown. (130-UTS pump is shown. Label placement is similar on other sizes.) If the pump is mounted on a bracket, the “Read and understand operation manual” label is placed on the arm of the bracket.

IMPORTANT

1. Pump and Drive are factory aligned.
2. Recheck alignment after installation and before start-up.
3. Recheck alignment periodically, to maximize service life.

33-95

PD100-235b

Part no: 33-95

This label is supplied on base packages, on the side of the gear case.

IMPORTANT

To avoid damage to the shaft seals and/or pump parts:

DO NOT START this pump unless Seal Flush has been installed and is turned ON.

PD100-236a

Part no: 112446+

This label is supplied with pumps with double mechanical seals. It is attached to the eye bolt.

Care of Component Materials

NOTE: SPX FLOW recommends the use of an FDA-approved anti-seize compound on all threaded connections.

WARNING

Failure to comply with the Care of Component Materials could lead to bodily injury.

Stainless Steel Corrosion

Corrosion resistance is greatest when a layer of oxide film is formed on the surface of stainless steel. If film is disturbed or destroyed, stainless steel becomes much less resistant to corrosion and may rust, pit or crack.

Corrosion pitting, rusting and stress cracks may occur due to chemical attack. Use only cleaning chemicals specified by a reputable chemical manufacturer for use with 300 series stainless steel. Do not use excessive concentrations, temperatures or exposure times. Avoid contact with highly corrosive acids such as hydrofluoric, hydrochloric or sulfuric. Also avoid prolonged contact with chloride-containing chemicals, especially in presence of acid. If chlorine-based sanitizers are used, such as sodium hypochlorite (bleach), do not exceed concentrations of 150 ppm available chlorine, do not exceed contact time of 20 minutes, and do not exceed temperatures of 104°F (40°C).

Corrosion discoloration, deposits or pitting may occur under product deposits or under gaskets. Keep surfaces clean, including those under gaskets or in grooves or tight corners. Clean immediately after use. Do not allow equipment to set idle, exposed to air with accumulated foreign material on the surface. Corrosion pitting may occur when stray electrical currents come in contact with moist stainless steel. Ensure all electrical devices connected to the equipment are correctly grounded.

Alloy 88

Waukesha Alloy 88 is the standard rotor material for Universal I, Universal II, Universal TS, Universal Lobe, Universal 420/520 and 5000 Series Rotary PD pumps. This alloy was developed specifically for corrosion resistance and close operating clearance requirements of high performance rotary positive displacement pumps. Alloy 88 is a nickel based, corrosion-resistant, non-galling or seizing material. The ASTM designation is A494 Grade CY5SnBiM (UNS N26055), and the material is listed in the 3-A Sanitary Standards as acceptable for product contact surfaces.

The corrosion resistance of Alloy 88 is approximately equal to AISI 300 Series Stainless Steel. However, Alloy 88 has limited resistance to certain aggressive chemicals that may be commonly used in contact with AISI 300 Series Stainless Steel.

Do not use Alloy 88 in contact with nitric acid. Nitric acid is commonly used to passivate new installations of stainless steel equipment. Do not allow nitric acid based passivation chemicals to contact Alloy 88 rotors. Remove the rotors during passivation and use a separate pump to circulate the passivation chemicals. Also, if nitric acid-based CIP cleaning chemicals are used, remove the rotors prior to CIP cleaning and clean them separately by hand in a mild detergent. If you have questions regarding other aggressive chemicals, please contact SPX FLOW Application Engineering for assistance.

Aluminum

Aluminum is a “soft” metal; hard sharp objects will damage the surface. The Hard Coat Anodized Sealed surface provides corrosion and wear protection. Use caution when installing and removing the cover while servicing the pump. If the surface of the aluminum cover is damaged, replace with a new cover. The gear shrouds are not anodized, but are located inside the oil sump. Should they become damaged during servicing, replace with new parts.

Elastomer Seal Replacement Following Passivation

Passivation chemicals can damage product contact areas of this equipment. Elastomers (rubber components) are most likely to be affected. Always inspect all elastomer seals after passivation is completed. Replace any seals showing signs of chemical attack. Indications may include swelling, cracks, loss of elasticity or any other noticeable changes when compared with new components.



Introduction

Pump Receiving

⚠ DANGER

The pump contains internal moving parts. DO NOT put hands or fingers into the pump body ports or drive area at any time during operation. To avoid serious injury, DO NOT install, clean, service, or repair the pump unless all power is off and locked out and the pump is de-pressurized.

All ports are covered at the factory to keep out foreign objects during transit. If covers are missing or damaged, remove the pump cover (if damaged) and thoroughly inspect the fluid head. Be sure that the pumping head is clean and free of foreign material before rotating the shaft.

The Waukesha Cherry-Burrell brand Universal Twin Screw pump uses a screw style rotor. The terms “Screw” and “Rotor” can be used interchangeably when referring to the screw style rotors.

Each standard Waukesha Cherry-Burrell brand pump is shipped completely assembled and lubricated. Review “Operation” on page 25 before operating the pump.

Intended Use

The Waukesha Cherry-Burrell brand Universal Twin Screw pump is exclusively intended for pumping liquids, especially in food and beverage installations.

Refrain from using the pump in a manner which exceeds the scope and specifications stated below.

Any use exceeding the margins and specifications set forth is considered to be not intended.

SPX FLOW is not liable for any damage resulting from such activities. The user bears the full risk.

⚠ WARNING

Improper use of the pump leads to:

- *damage*
- *leakage*
- *destruction*
- *potential failures in the production process*

Equipment Serial Number

All Waukesha Cherry-Burrell brand pumps are identified by a serial number on the gear case nameplate, which is stamped on the pump body and cover.

Certifications

EHEDG

Only pumps containing the elastomers and seals listed on the EHEDG certificate are EHEDG-certified. To maintain compliance, pumps must have process connections that meet EHEDG guidelines and must be mounted in a free-drain position.

Pumps must be connected to process piping using sanitary welds or EHEDG-approved process connections as described in the EHEDG Position Paper, “Easy cleanable Pipe couplings and Process connections” found under “Free Documents” on www.EHEDG.org.

3-A

Only designs meeting 3-A Standards are 3-A certified. To maintain compliance, pumps must have process connections that meet 3-A Standards and must be mounted in a free-drain position.

See the 3-A website for current certificates: www.3-a.org/3-A-Symbol/Search-Database-of-Current-Certificates.

Certificate Number 29 covers all SPX FLOW Centrifugal and Rotary Pumps. You can search using: Certificate Number 29, Company Name “SPX Flow US, LLC,” or Standard Number 02-___. The 3-A Standard for fittings is 63-___. (“___” indicates the current revision.)

Operating Parameters

UTS Model	Screw Pitch (mm)			Maximum Nominal Capacity (gpm)	Horizontal Port (Cover)	Vertical Port (Body)	Max. Pressure Range	Max. RPM	Temp.*	
	Displacement (gal./revolution)									
015	16.5	33	44	0.10 – 70	2"	1.5"	375 psi / 25.8 bar	3500	Max. Gearcase temp: 197°F / 91°C	
	0.016	0.031	0.041							
030	16.8	28	42	0.40 –130	2.5"	2"		3100		Max. product temp: 300°F / 149°C
	0.030	0.050	0.076							
130	36.7	55	73.4	4.00 –350	4"	2.5"		2500		
	0.119	0.178	0.239							
220	45	60	90	40.0 –880	4" or 6"	4" or 6"	2000			
	0.301	0.44	0.605							

* Max Oil temperature of 197°F (91°C) requires the pump to be shut down, and allowed to cool off. The surface temperature of the gear case may exceed 160°F (71°C). Contact SPX FLOW Application Engineering for higher pressure or higher temperature applications.

⚠ DANGER

Operating the pump outside the stated operating parameters may result in severe personal injury or death.



Qualification Guidelines for Operating Staff

Definitions

Operator

A person who is capable of handling the installation, interior, operation, warnings, cleaning, repair or transportation of the machine.

Trained person

A person who is instructed in the tasks given and the possible dangerous situation that may occur. The person is also aware of the protection installations and measures.

Skilled worker

A person who is based upon his or her background and due to his or her knowledge, is able to perform the tasks, and has an appropriate knowledge of the provisions given.

Table 1: Qualification Guidelines for Operating Staff

Phase of Life	Task Example	Prerequisite for the operating staff	
		Trained person	Skilled worker
Transport	Lift	x	
	Loading	x	
	Unloading	x	
Assembly and Installation/ Commissioning	Assembly/fastening of the machine		x
	Connection to the electric grid		x
	Filling of lubricant to drive motors	x	
Operation	Startup	x	
	Controlling	x	
	Surveillance	x	
	Shutdown	x	
Cleaning, Maintenance	Cleaning	x	
	Refilling of lubricants	x	
	Disconnection from energy supply	x	
	Assembly/Disassembly of parts	x	
Troubleshooting	Disconnection from energy supply	x	
	Troubleshooting	x	
	Assembly/Disassembly of parts	x	
	Repair	x	
Dismounting/Unplugging from plant	Removal of energy supply	x	
	Dismount		x
	Lift		x
	Loading		x
	Unloading		x

Installation

Important Safety Information

⚠ DANGER

The pump contains internal moving parts. DO NOT put hands or fingers into the pump body ports or drive area at any time during operation. To avoid serious injury, DO NOT install, clean, service, or repair the pump unless all power is off and locked out, and the pump is de-pressurized.

⚠ WARNING

The pump components and piping may contain sharp edges. Handle the screws carefully because edges may be sharp. Wear gloves while installing and servicing the pump to help avoid injuries from these hazards.

⚠ CAUTION

Maintenance should be performed only by trained personnel. See "Qualification Guidelines for Operating Staff" on page 15.

Lifting

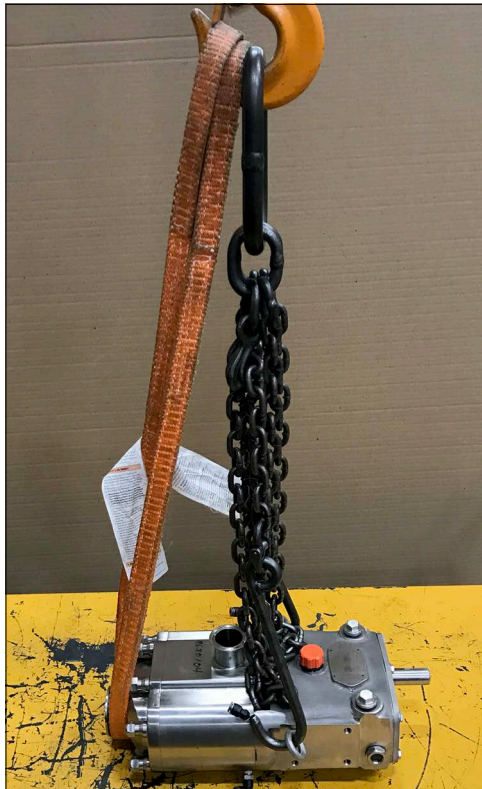

Figure 1 - Lifting location - 015, 030-UTS

⚠ CAUTION

When moving the pump, use appropriate lifting devices. Always use securely fitted lifting straps/chains when lifting with a crane or similar lifting gear.

⚠ WARNING

Do not stand underneath the pump while it is being lifted.

Attach lifting devices as shown:

- On the 015-UTS, and 030-UTS (Figure 1 and Figure 2), attach straps/chains to the two eye bolts on either side of the gear case, and slide a strap under the horizontal port on the cover.



Figure 2 - Lifting location detail - 015, 030-UTS



Figure 3 - Lifting location - 130, 220-UTS

- On the 130-UTS and 220-UTS (220-UTS pictured in Figure 3), attach lifting straps/chains to the two eye bolts on either side of the gear case, and to the single vertical eye bolt located in front of the vertical port.
- For Unit orders (a pump and motor mounted on a common baseplate (not pictured)), use straps to lift the unit by the baseframe at either end. Do not lift by the eye bolts on the pump or motor.

⚠ CAUTION

To lift the cover on a 220-UTS, attach lifting straps or chains to the eye bolt.

To lift the body of a 130-UTS, use a lifting strap or chain threaded through the eye bolt on the body.

To lift the body of a 220-UTS, use a lifting strap threaded through the vertical port on the body, and the front of the body (not through the shaft bores).

To lift the gear case assembly on the 130-UTS or 220-UTS, attach lifting straps/chains to the two eye bolts on either side of the gear case.

To lift the screw rotors on the 130-UTS and 220-UTS, please have your maintenance department seek advice for safe lifting practices for objects weighing in excess of 40 lb (18 kg). The screw surfaces must be protected to maintain the 32 Ra surface finish for sanitary applications. It may be necessary to design or purchase a specialized lifting tool to cradle and lift the screws when meshed.

To lift the shafts on the 220-UTS, please have your maintenance department seek advice for safe lifting practices for objects weighing in excess of 40 lb (18 kg).

Table 2: Universal Twin Screw Pump Weights (less motor or base)

Model	Weight
015-UTS	87 lb (39 kg)
030-UTS	160 lb (73 kg)
130-UTS	385 lb (175 kg)
220-UTS	750 lb (340 kg)

Install Pump and Drive Unit

⚠ CAUTION

Install the pump and piping system in accordance with local codes and restrictions. Practices described in this manual are recommended for optimum performance.

⚠ CAUTION

The motor must be installed by qualified personnel, e.g., a licensed electrician.

All system equipment, such as motors, sheaves, drive couplings, speed reducers, etc., must be properly sized to ensure satisfactory operation of your Waukesha Cherry-Burrell brand pump within its limits. Customer-supplied motors should have a basic level of safety to prevent electrical hazards, and should be dealt with in accordance with the manufacturer's instructions.

In a typical installation configuration, the pump and drive unit are mounted on a common base plate. The unit can be installed in any of the arrangements shown in Figure 4 through Figure 7.

NOTE: The gap between the pump body and gearcase is required for 3-A sanitary standards.

NOTE: When installing a unit as shown in Figure 7, level the unit before installing the bolts.

The shaded area in Figure 4 through Figure 7 indicates the guard location.

See "Pump Shaft Guards" on page 124.

⚠ WARNING

Full guards must be installed to isolate operators and maintenance personnel from rotating components.

Guards are provided as part of a complete pump and drive package are selected by SPX FLOW Engineering for the pump, base, and motor ordered. Do not modify the guard provided by SPX FLOW. If the guard provided by SPX FLOW is lost, contact SPX FLOW Customer Service and provide your order number or PO number of the pump to order a correctly-sized replacement guard.

If the pump was not purchased as a unit, it is the responsibility of the customer to ensure proper guarding. Refer to your local regulations for guidance.

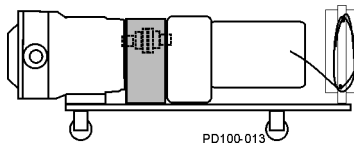

Figure 4 - Portable Base

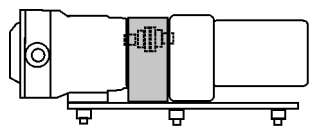

Figure 5 - Adjustable Leg Base

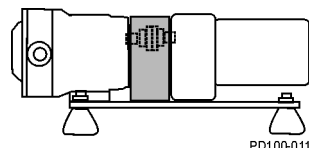

Figure 6 - Leveling and/or Vibration Isolation Pads

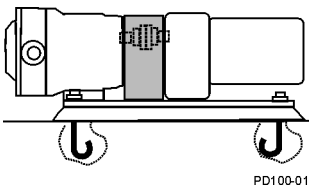

Figure 7 - Permanent Installation on Foundation

Direction of flow

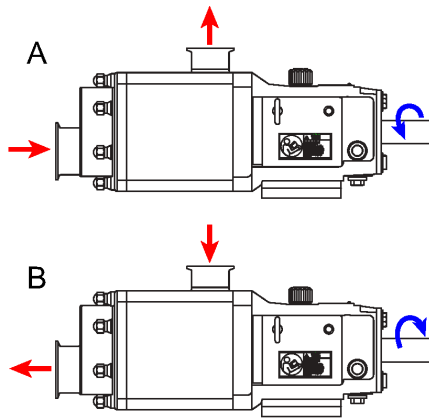

Figure 8 - Direction of flow

The default direction of flow is from the horizontal port (in the front of the cover) to the vertical port, with the drive shaft running clockwise as viewed facing the cover of the pump. See view A in Figure 8.

To change the direction of flow, run the drive shaft in the opposite direction (counter-clockwise), as viewed facing the cover of the pump. See view B in Figure 8.

Install Connections and Piping

⚠ CAUTION

These pumps are positive displacement design and will be severely damaged if operated with closed valves in discharge or inlet lines. The pump warranty is not valid for damages caused by a hydraulic overload from operation or start-up with a closed valve in the system.

Piping Support

To minimize forces exerted on the pump, support all piping to the pump independently with hangers or pedestals. Such forces can cause misalignment of the pump parts and lead to excessive wear of screws, bearings, and shafts.

Figure 9 shows typical supporting methods used to independently support each pipe, reducing the weight effect of piping and fluid on the pump.

⚠ WARNING

Do not exceed 50 lb (22.7 kg) load on the pump inlet or discharge ports. Exceeding this limit may cause damage to the pump

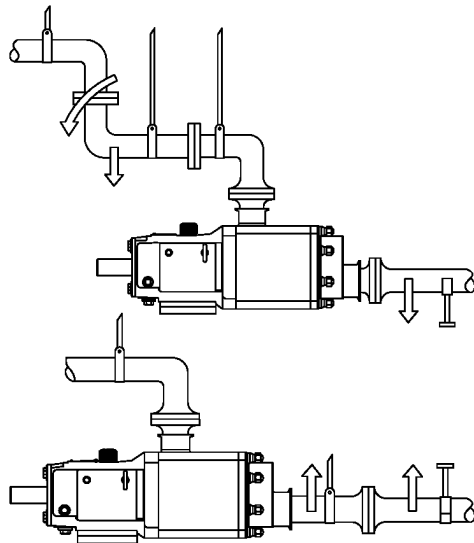

Figure 9 - Piping Support

Expansion Joints

Thermal expansion of piping can cause tremendous forces. Use thermal expansion joints to minimize these forces on the pump.

Flexible joints can be used to limit transmission of mechanical vibration. Ensure that the free ends of any flexible connections in the system are anchored.

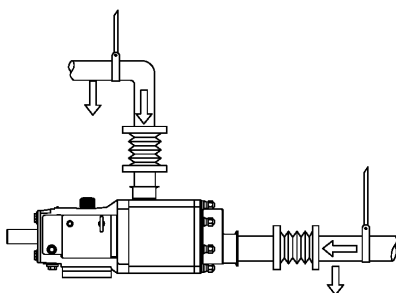

Figure 10 - Flexible Connections and Supports

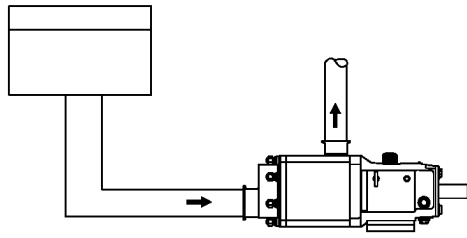

Figure 11 - Pump Below Supply (recommended)

Inlet Piping

Install the pump below the supply liquid level to reduce the air in the system by flooded suction, to prevent the pump from becoming air-bound (Figure 11).

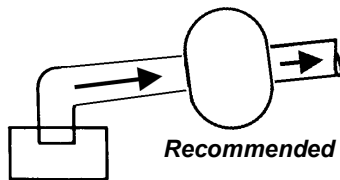
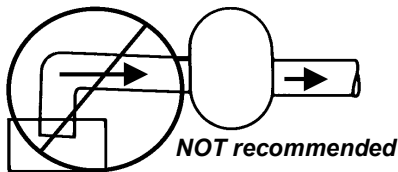

Figure 12 - Piping Slope

If the pump is installed above the supply liquid level, the piping on the inlet side must slope up toward the pump, preventing air pockets in the pipes (Figure 12).

Install Check Valves

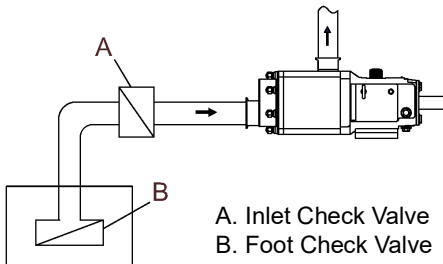
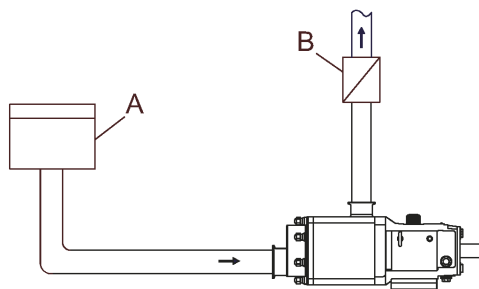

Figure 13 - Inlet Check Valve

Inlet Side on Lift Applications

Use check valves to keep the inlet line full, particularly with low-viscosity fluids (Figure 13).



- A. Closed Tank - produces vacuum on liquid (Low Absolute Pressure)
- B. Check Valve (outlet)

Figure 14 - Discharge Check Valve

Discharge Side

For systems with liquid under a vacuum, install a check valve on the discharge side of the pump. The check valve prevents backflow (air or fluid) to aid in the initial start-up by minimizing the required differential pressure supplied by the pump to start the flow (Figure 14).

Install Isolation Valves

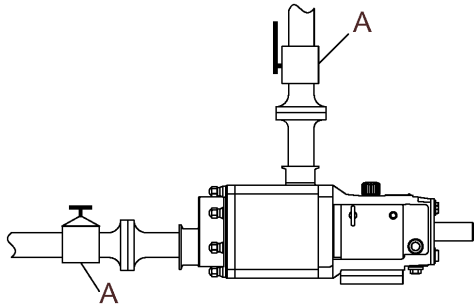

Figure 15 - Isolation Valves

Isolation valves permit pump maintenance and safe pump removal without draining the system (Figure 15, item A).

NOTE: Make sure the inlet flow is not restricted. Do not start the pump deadheaded, e.g., operated with no flow through it.

Install Relief Valves

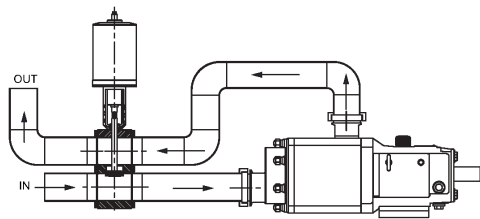

Figure 16 - WR63 Reverse-Acting Over-Pressure Relief Valve

Install relief valves to protect the pump and piping system against excessive pressure. We recommend installing an external relief valve designed to bypass fluid from the pump outlet to the inlet side of the system (See Figure 16, Figure 17, and Figure 18).

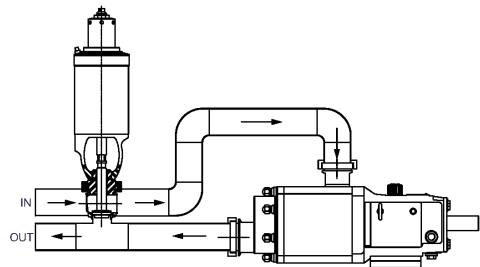

Figure 17 - WR61C Air-to-Raise Valve with Adjustable-Spring Actuator

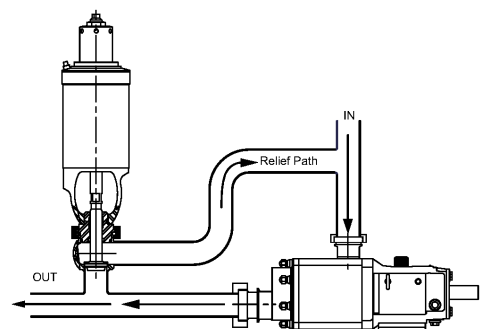
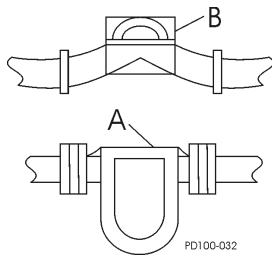

Figure 18 - WR61T 4RHAR Valve

Inlet Side Strainers and Traps



A. Strainer B. Magnetic Trap

Figure 19 - In-line Strainers and Traps

Inlet side strainers and traps (Figure 19, items A and B, respectively) can be used to prevent foreign matter from damaging the pump. Select carefully to prevent cavitation caused by the restriction of the inlet. If inlet strainers are used, they must be serviced regularly to prevent clogging and flow stoppage.

Install Pressure Gauges

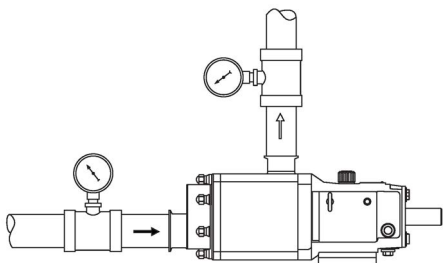

Figure 20 - Pressure and Vacuum Gauges

Pressure and vacuum gauges provide valuable information about pump operation (Figure 20). Wherever possible, install the gauges to help provide information on the following:

- Normal or abnormal pressures
- Indication of flow
- Changes in pump condition
- Changes in system conditions
- Changes in fluid viscosity

Seal Flush Connections

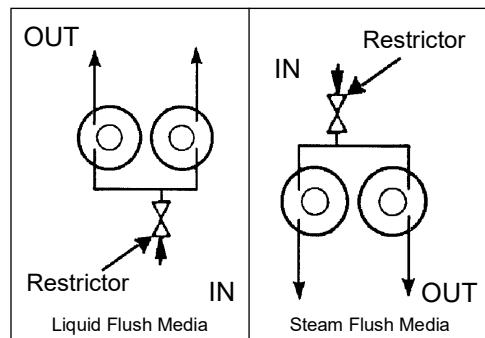

Figure 21 - Flush Piping Setup

Pumps with double seals require flushing. The flush media (water or lubricating fluid compatible with the product) must be connected and flowing whenever the pump is operated.

⚠ WARNING

Operating the pump without flush will damage the seal and pump parts due to excess heat from dry running.

⚠ CAUTION

Check for buildup or restrictions (kinking) in the flush lines or fittings at regular intervals. SPX FLOW recommends using clear (transparent) flush lines for easier observation.

Pump bodies have 4 1/8-inch female pipe thread (NPT) flush connections located near the bottom and top of the body.

1. Connect the flush inlet to the lower connection, and outlet to upper connection to flood the flush area completely.
2. Connect the flush outlet for unrestricted flow to the drain.
3. Use cool, filtered flush media to obtain maximum service life of the seal components. If the pumped product is sticky or solidifies at room temperature, use warm or hot flush media.
4. Install a pressure reducing valve and flow control valve (needle valve) on the flush supply line. Set the supply pressure at a maximum of 30 psi (2 bar) and adjust the flow rate to approximately 1/4 gpm (more for high temperature applications).

NOTE: *If steam is used as a flush media, connect the inlet at the upper connection, and the outlet at the lower connection to ensure condensation removal.*

If steam condensate is used as a flush media, connect the inlet at the lower connection, and the outlet at the upper connection.

- Also install a solenoid valve in the flush supply and wire it in series with the motor starter to provide an automatic start/stop of the flush media flow before the motor turns on and after the motor turns off.

CIP (Clean-In-Place) Features

Universal Twin Screw pumps function as a CIP pump and a product pump in one. Run the pump at fast speeds (1300-3500 RPM) for CIP; slower speeds for product. These pumps are designed to provide complete access of the CIP solutions to all product contact surfaces.

Standard CIP features include

- Free draining cover
- Custom cover gasket to exclude small particulates (seeds)

Guidelines

Use the following guidelines when designing and installing the CIP system to ensure successful cleaning:

CAUTION

In order to avoid temperature shock after the introduction of hot CIP fluid, stop the pump after filling the pumphead with hot CIP fluid. Once the hot CIP fluid has filled the pumphead, allow up to 15 minutes for the pump fluid components to thermally expand, then re-start the pump.

- Ensure that the velocity rate of CIP solutions is adequate to clean the entire circuit. For most applications, a velocity of 5 ft/sec is sufficient. For the CIP solution to achieve the proper velocity, the pump drive must have enough speed range and horsepower. The required inlet pressure also must be satisfied.
- Ensure that a differential pressure is created across the pump. Differential pressure will push CIP solutions through close-clearance areas of the pump, resulting in better cleaning action. The high pressure side may be either the inlet or outlet side. 30 psi (2 bar) differential pressure is adequate for most applications. For difficult cleaning applications, higher pressure or longer cleaning cycles may be required.
- If the Universal Twin Screw (UTS) pump is not the pump being used for CIP, the UTS pump must still be operated during CIP to increase turbulence and cleaning action within the pump.

Check Angular Alignment

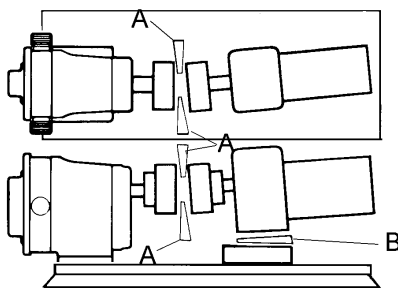

Figure 22 - Check Angular Alignment

- Using feeler gauges or taper gauges (Figure 22, items A and B), check the alignment at four points every 90 degrees around the coupling; **adjust to equal dimension at all points.**
- Set the space between the coupling halves to the manufacturer's recommended distance.
- Install shims to bring the system into alignment.

Check Coupling Alignment



Figure 23 - Lovejoy Coupling



Figure 24 - T.B. Woods® Coupling

Pumps and drives ordered from the factory and mounted on a common base plate are aligned before shipment. Alignment **must** be re-checked after the complete unit has been installed and piping completed. Periodic re-checking is advisable during the pump service life.

- SPX FLOW recommends using a flexible coupling to connect the drive to the pump. Several different types are available, including couplings with slip or overload provisions. SPX FLOW provides Lovejoy (Figure 23) or T.B. Woods® (Figure 24) couplings unless otherwise specified when ordering. Flexible couplings can be used to compensate for end play and small differences in alignment.
- Align the pump and drive shaft as closely as possible:
 - Pump and Drive are factory aligned.
 - Re-check alignment after installation and before start-up.
 - Re-check alignment periodically, to maximize service life.

Check Parallel Alignment

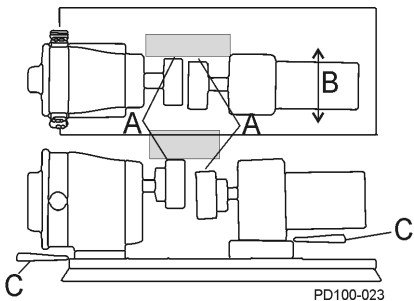

Figure 25 - Check Parallel Alignment

1. Check both the horizontal and vertical alignment of the pump and drive using a straight edge.
2. Using a feeler gauge at location "A" in Figure 25, determine the direction and amount of movement needed (Figure 25, item B).
3. If necessary, shim at location "C" and/or move drive as needed.

Check Belt and Chain Drive Alignment

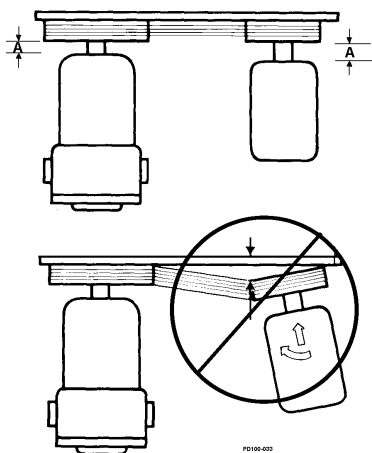

Figure 26 - Aligning Belt and Chain Drives

Use a straight edge to visually check the belt or chain alignment. Keep the shaft distance to a minimum (Figure 26, item A).

After the piping is complete and before the belts are installed, manually turn the pump shaft to ensure it turns freely.

Operation

Important Safety Information

⚠ DANGER

The pump contains internal moving parts. DO NOT put hands or fingers into the pump body ports or drive area at any time during operation. To avoid serious injury, DO NOT install, clean, service, or repair the pump unless all power is off and locked out and the pump is de-pressurized.

⚠ WARNING

The pump components and piping may contain sharp edges. Handle the screws carefully because edges may be sharp. Wear gloves while installing and servicing the pump to help avoid injuries from these hazards.

⚠ CAUTION

Maintenance should be performed only by trained personnel. See “Qualification Guidelines for Operating Staff” on page 15.

⚠ CAUTION

These pumps are positive displacement design and will be severely damaged if operated with closed valves in the discharge or inlet lines. The pump warranty is not valid for damages caused by a hydraulic overload from operation or start-up with a closed valve in the system.

Pre-Startup Checklist

⚠ CAUTION

The motor must be installed by qualified personnel, e.g., a licensed electrician.

⚠ CAUTION

Consult the motor or VFD manufacturer's manual for setup, operation, disassembly, and troubleshooting of the motor or VFD, or contact the manufacturer.

⚠ CAUTION

Do not use this pump to flush a newly-installed system. Severe damage may occur to the pump and system if the pump is used to flush the system.

⚠ WARNING

Full guards must be installed to isolate the operators and maintenance personnel from the rotating components. Guards are provided as part of a complete pump and drive package. See page 18 and page 124.

⚠ WARNING

Do not start a pump with seal flush unless the seal flush is installed and turned on.

1. Ensure that the pump is correctly installed as described in “Installation” on page 16. Review “Install Relief Valves” on page 21 and install relief valves as needed.
2. Check the coupling alignment. See “Check Coupling Alignment” on page 24.
3. Ensure that the pump and piping are clean and free of foreign material such as welding slag, gaskets, etc.
4. Ensure that all piping connections are tight and leak-free. Where possible, check the system with non-hazardous fluid.
5. Ensure that the pump and drive are lubricated. See “Lubrication” on page 28.
6. Ensure that all guards are in place and secure.
7. Double mechanical seals require adequate supply and flow of clean flushing fluids.
8. Ensure that all valves are open on the discharge side and a free flow path is open to the destination.
9. Ensure that all valves are open on the inlet side and fluid can fill the pump. A flooded suction installation is recommended.
10. Check the direction of pump and drive rotation to ensure that the pump will rotate in the proper direction. See “Direction of flow” on page 19.

Starting the Pump

⚠ WARNING

Keep a safe distance (1.6 ft/.5 m) away from the pump during startup.

⚠ CAUTION

The motor must be installed by qualified personnel, e.g., a licensed electrician.

⚠ CAUTION

In order to avoid temperature shock after the introduction of hot or cold product, stop the pump after filling the pumphead with product. Once the product has filled the pumphead, allow up to 15 minutes for the pump's fluid components to thermally adjust, then re-start the pump.

1. Start the pump drive. Where possible, start at a slow speed or jog.
2. For sanitary applications, sanitize the pump per customer requirements before putting the pump into service.
3. Check to make sure that the liquid is reaching the pump. If pumping does not begin and stabilize, check "Troubleshooting" on page 119.

Stopping the Pump

⚠ WARNING

Keep a safe distance (1.6 ft/.5 m) away from the pump during shutdown.

⚠ CAUTION

The motor must be installed by qualified personnel, e.g., a licensed electrician.

1. Shut off the power to the pump drive.
2. Shut off the supply and discharge lines.



Maintenance

Important Safety Information

⚠ DANGER

The pump contains internal moving parts. DO NOT put hands or fingers into the pump body ports or drive area at any time during operation. To avoid serious injury, DO NOT install, clean, service, or repair the pump unless all power is off and locked out and the pump is de-pressurized.

⚠ WARNING

The pump components and piping may contain sharp edges. Handle the screws carefully because edges may be sharp. Wear gloves while installing and servicing the pump to help avoid injuries from these hazards.

⚠ WARNING

Never touch the gear case during operation. The surface temperature of the gear box can get above 160°F (71°C) when running at 1000-3500 RPM.

⚠ CAUTION

Maintenance should be performed only by trained personnel. See “Qualification Guidelines for Operating Staff” on page 15.

⚠ CAUTION

Make sure the pump is securely bolted or clamped down prior to performing any maintenance work. The pump center of gravity changes as parts are added or removed, and could result in tipping of an unsecured pump.

⚠ CAUTION

Make sure to keep the work area clear of machine parts, tools, product lines, foreign materials, and power cables to avoid potential hazards.

⚠ CAUTION

Make sure appropriate lighting is available: at least 1000 lux, independent of daylight and weather conditions.

⚠ CAUTION

Before carrying out any maintenance and repair work on cold components, ensure that the machine parts in question are sufficiently heated. The contact temperature of accessible machine parts must not be lower than those in the EN ISO 13732-1.

⚠ CAUTION

To lift the cover on a 220-UTS, attach lifting straps or chains to the eye bolt.

To lift the body of a 130-UTS, use a lifting strap or chain threaded through the eye bolt on the body.

To lift the body of a 220-UTS, use a lifting strap threaded through the vertical port on the body, and the front of the body (not through the shaft bores).

To lift the gear case assembly on the 130-UTS or 220-UTS, attach lifting straps/chains to the two eye bolts on either side of the gear case.

⚠ CAUTION

To lift the screw rotors on the 130-UTS and 220-UTS, please have your maintenance department seek advice for safe lifting practices for objects weighing in excess of 40 lb (18 kg). The screw surfaces must be protected to maintain the 32 Ra surface finish for sanitary applications. It may be necessary to design or purchase a specialized lifting tool to cradle and lift the screws when meshed.

To lift the shafts on the 220-UTS, please have your maintenance department seek advice for safe lifting practices for objects weighing in excess of 40 lb (18 kg).

Before detaching port connections to the pump:

- Close the suction and discharge valves.
- Drain the pump and clean or rinse, if necessary.
- Disconnect or shut off the electrical supply and lock out all power.

Lubrication

Table 3: Lubrication Quantities

UTS Model	Oil Capacity
015	110 ml / 3.7 oz
030	216 ml / 7.3 oz
130	525 ml / 17.8 oz
220	1575 ml / 53.3 oz

Oil Specification

Standard: Synthetic Mobil SHC 629-150

Food Grade: Synthetic Mobil SHC
Cibus-150

Maintenance Inspections

⚠ DANGER

The pump contains internal moving parts. DO NOT put hands or fingers into the pump body ports or drive area at any time during operation. To avoid serious injury, DO NOT install, clean, service, or repair the pump unless all power is off and locked out and the pump is de-pressurized.

Drive

Refer to the manufacturer's manual shipped with the drive for proper drive lubrication and frequency.

Gears and bearings

Gears and bearings are factory-lubricated with gear oil at the quantity shown in Table 3. **First oil change at 250 hours, then every 2000 hours, depending on the operating conditions.** Aggressive washdown or extreme running conditions may require more frequent lubrication intervals.

When the pump is not running, the oil level is correct when the oil level is visible in the sight glass.

When the pump is running, the oil level may be difficult to see and may appear cloudy. Universal TS pumps are shipped with the oil level at or slightly above the center of the sight glass.

Check the oil level frequently, at least weekly.

Check the oil for signs for moisture; when contaminated with water, oil makes an emulsion similar to mayonnaise.

Detecting wear in the early stages can reduce repair costs and down time. A simple "look-feel" inspection of the pump during breakdown cleaning is recommended to detect signs of trouble at an early stage.

Refer to the "Maintenance Inspection Chart" on page 29 for possible causes and solutions to common issues discovered during inspection.

A detailed maintenance inspection should be scheduled annually. See "Annual Maintenance" on page 30.



Maintenance Inspection Chart

Frequency	Check for	Possible Causes	Possible Solutions
At least weekly	Low oil level, oil contamination. See "Lubrication" on page 28.	Oil leak from back cover oil seal Loose back cover Breather plug damaged	Replace oil seal Replace back cover gasket and tighten bolts to spec. See page 117. Check or replace breather plug See "Lubrication" on page 28
Weekly	Leaks - Product	Damaged seal Damaged elastomers	Replace seal Replace elastomers
Weekly	Leaks - Oil	Damaged seal Damaged elastomers	Replace seal Replace elastomers Replace back cover gasket and tighten bolts to spec. See page 117.
Weekly	Leaks - Flush fluid Inspection (Double mechanical seal only): run flush and rotate the shaft. Look for leaks through the vertical port or through the end of the pump body. See Figure 108 on page 54.	Damaged seal, fitting, or flush tube Damaged elastomers.	Replace seal, fitting, or flush tube Replace elastomers
Every 3 months	Damaged bearing seals.	Seal may be old and worn. No oil on lips to lubricate. Shaft worn under seals. Worn bearings.	Replace seals. Properly lubricate with oil when installing. Inspect shaft surface under seals. Replace bearings.
Every 3 months	Damaged rear oil seal.	Seal may be old and worn. No oil on lips to lubricate. Shaft worn under seals. Not centered on shaft when installed. Worn bearings.	Replace seal. Properly lubricate with oil when installing. Inspect shaft surface under seals. Replace bearings.
Every 3 months	Screw flank contact or Screw outer diameter to bore contact.	Hard object jammed into screws and twisted shafts. Incorrectly timed screws. Worn bearings. Loose screw nut(s). Belleville-style washer(s) on backwards. Axial clearances not even. Worn bearings.	Replace shafts. Adjust screw timing to maintain proper axial clearances. Install strainers if necessary. Check and replace gears if necessary. Replace bearings Torque screw nut(s) properly. Install Belleville-style washers correctly. Verify axial clearances are even. Check and replace bearings. Reset.
Every 3 months	Worn screw or shaft spline(s).	Loose screw nut(s). Belleville-style washer(s) on backwards. Timing is off.	Replace screws or shafts. Torque screw nut(s). See page 117. Install Belleville-style washer(s) correctly.
Every 3 months	Worn screw end or shaft shoulder.	Loose screw nut(s). Belleville-style washer(s) on backwards. Screws slammed against shoulder when installed.	Torque screw nut(s). See page 117. Install Belleville-style washer(s) correctly. Replace screws and shafts or adjust screw timing to maintain proper axial clearances.



Frequency	Check for	Possible Causes	Possible Solutions
Every 3 months	Sharp edged shaft shoulder.	Loose screw nut(s). Belleville-style washer(s) on backwards. Screws slammed against shoulder when installed. Axial clearances not even.	Torque screw nut(s). See page 117. Install Belleville-style washer(s) correctly. Remove sharp edge with file to prevent cutting shaft o-ring. Verify axial clearances are even.
Every 3 months	Gear backlash.	Lack of lubrication. Excessive hydraulic loads. Loose shaft locking nut. Worn gears. Worn gear key.	Check lubrication level and frequency. Reduce hydraulic loads. Torque locking nuts to specified torque values. See page 117. Check and replace gears if necessary. Inspect gear key, shaft keyway and shaft, replace if necessary.
Every 3 months	Worn or broken gear teeth.	Lack of lubrication. Excessive hydraulic loads. Loose shaft locking nut.	Check and replace gears if necessary. Check lubrication level and frequency. Reduce hydraulic loads. Torque locking nuts to specified torque values. See page 117.
Every 3 months	Loose gears.	Shaft locking nuts not torqued properly. Locking assembly not torqued properly. Worn gear key.	Torque locking nut to specified torque value. See page 117. Check and replace gears if necessary. Inspect gear key, shaft keyway and shaft, replace if necessary.
Every 3 months	Loose bearings, axially or radially.	Lack of lubrication. Excessive hydraulic loads. Product or water contamination. Loose shaft locking nut.	Check lubrication level and frequency. Reduce hydraulic loads. Replace bearings if necessary. Torque locking nut to specified torque value. See page 117.

Annual Maintenance

DANGER

The pump contains internal moving parts. DO NOT put hands or fingers into the pump body ports or drive area at any time during operation. To avoid serious injury, DO NOT install, clean, service, or repair the pump unless all power is off and locked out and the pump is de-pressurized.

At least annually, perform the procedures and corrective measures outlined in "Maintenance Inspections" on page 28 and in the chart starting on page 29, in addition to the following preventive maintenance:

- Remove the gear cover and inspect the gears for wear, backlash and looseness. Check the gear retaining nuts. If they are loose, replace them with new nuts. Do not re-torque the existing nut as it is one-time use only. The gear case cover gasket is designed to compress when the back cover bolts are torqued. If you are re-installing a back cover that has previously been torqued down, replace the gear case cover gasket.
- Review the performance record on the pump, and check the radial clearances to determine wear and effect on performance. Adjustment to the operating speed can compensate for wear in some applications.

Cleaning

Determine the pump cleaning schedule on-site for materials being processed and plant maintenance schedule. See “CIP (Clean-In-Place) Features” on page 23.

To disassemble the fluid head, see “Fluid Head Disassembly” on page 32. Remove and clean the cover gasket, pump seals, and the screw nut assembly. Inspect and replace them as necessary.

NOTE: *Always replace the screw nut O-rings, seal cap O-rings, and seal carrier O-rings when reassembling the pump. If the area behind these seals becomes soiled, contact SPX FLOW Application Engineering for a specific cleaning and sanitizing procedure validated to remove bacteria. If a chlorine solution (200 ppm available chlorine) is used, it should leave no residual deposits which would remain in the pump.*

Acid cleaners have a much higher metal corrosion rate and pump parts should remain in acid cleaning solutions no longer than necessary. Any strong inorganic mineral-based acids that are harmful to your hands would be harmful to pump parts. See “Care of Component Materials” on page 13.

In applications where material can harden in the pump during shutdown, a CIP cleaning, flush, or disassembly of the fluid head and manual cleaning is strongly recommended.



Fluid Head Disassembly

⚠ DANGER

The pump contains internal moving parts. DO NOT put hands or fingers into the pump body ports or drive area at any time during operation. To avoid serious injury, DO NOT install, clean, service, or repair pump unless all power is off and locked out and the pump is de-pressurized.

⚠ DANGER

To avoid serious injury, shut off and drain all product from the pump prior to disconnecting the piping.

⚠ WARNING

The pump components and piping may contain sharp edges. Handle the screws carefully because edges may be sharp. Wear gloves while installing and servicing the pump to help avoid injuries from these hazards.

Remove cover

1. Remove the cover nuts from the cover as shown in Figure 27.

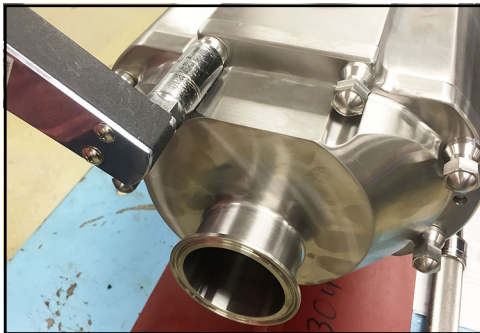

Figure 27 - Remove cover nuts

2. Remove the cover from the body. If necessary, use a soft hammer to tap the cover off the body studs and dowel pins as shown in Figure 28.

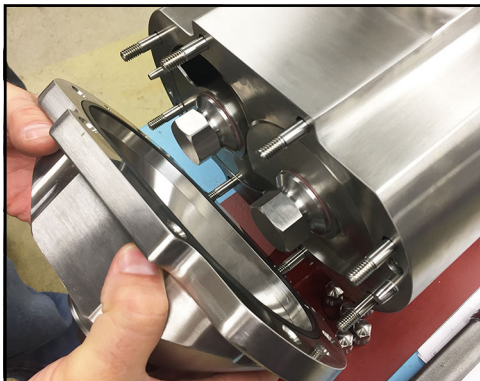

Figure 28 - Remove pump cover

⚠ CAUTION

To lift the cover on a 220-UTS, attach lifting straps or chains to the eye bolt.

3. Remove and inspect the cover gasket as shown in Figure 29.

NOTE: On the 220-UTS (not pictured), this gasket is installed in the groove on the body, not on the cover.



Figure 29 - Remove cover gasket



Figure 30 - Direction of tool

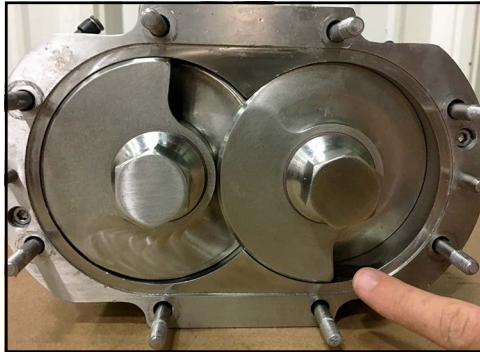

Figure 31 - Turn screws

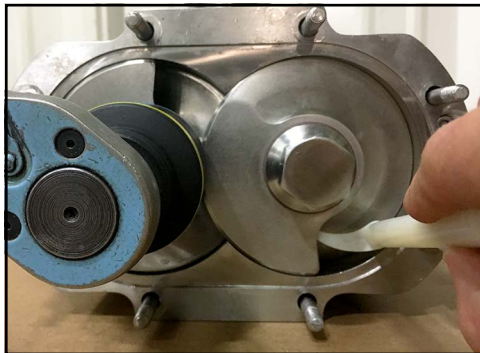

Figure 32 - Insert wedge

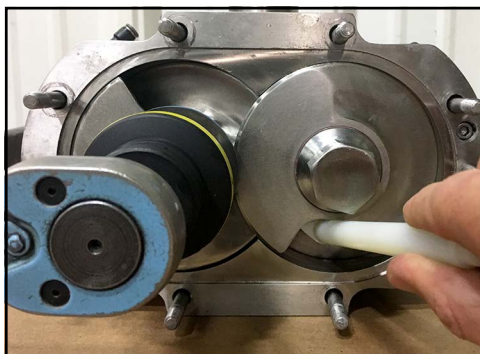

Figure 33 - Turn dowel

Remove screw nuts - All models except 220-UTS

NOTE: For 220-UTS, skip to page 34.

1. For all models except the 220-UTS, arrange the Screw Nut Tool (part number 139883+) as shown in Figure 30, making sure the wedge curves upward to the left.
2. Turn the screws by hand until the end of the thread of the right-hand screw is lined up to the bottom of the body as shown in Figure 31.
3. Insert the wedge of the assembly tool into the gap behind the right-hand screw thread as shown in Figure 32.
4. Turn the tool clockwise until the wedge is in contact with the screws. Begin to loosen the left-hand screw nut with the wrench. The wedge should begin to engage in between the outside diameter of the left-hand screw and root diameter of the right-hand screw. This prevents the screws from turning.
5. With the wedge engaged, loosen the left-hand screw nut. When the screw nut is loose, remove it by hand.

NOTE: If the wedge does not engage soon enough, it may be pushed out of place before the screw nut is loosened. If this occurs, insert the wedge again and make sure the tip of the wedge is located in between the screws.
6. After removing the left-hand screw nut, switch the wrench to the right-hand screw nut and turn it counter-clockwise. This releases the assembly tool.

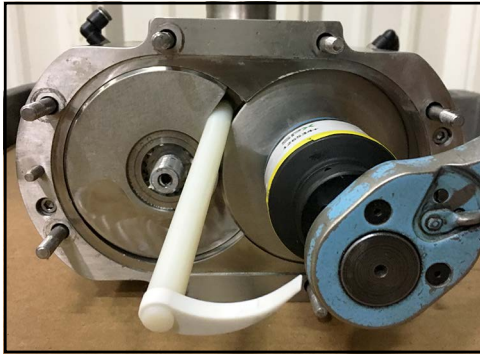

Figure 34 - Insert dowel

7. Turn the right-hand screw until the end of the thread of the left-hand screw lines up with the top.
8. Insert the screw nut tool in the gap between the left-hand screw thread and the outside diameter of the right-hand screw. This blocks the screws from turning.
9. Loosen the right-hand screw nut, then remove it by hand.
10. Skip to "Remove screws" on page 35.

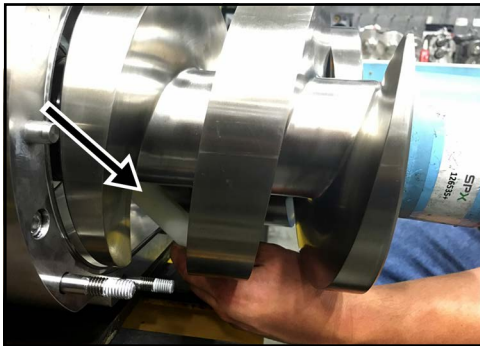

Figure 35 - Block screw

Remove screw nuts - 220-UTS only

1. Using the screw blocker (part number 139790+), block the left-hand screw from the back of the screw as shown in Figure 31 and loosen the left-hand screw nut.



Figure 36 - Insert block

2. Insert the blocker in the left-hand screw thread as shown in Figure 36. Loosen the right-hand screw nut.

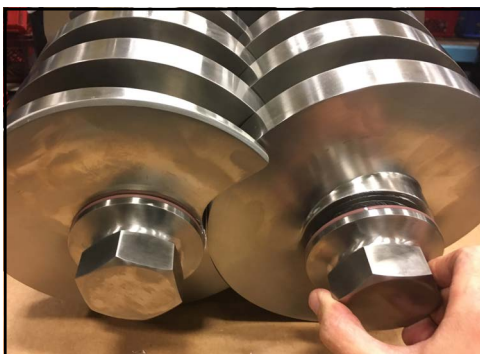

Figure 37 - Remove screw nuts

3. Remove both screw nuts as shown in Figure 37.

NOTE: An alternate method to removing the left-hand screw nut: Use a wrench and a plastic mallet to jar the screw nut loose, then secure the coupling with a pipe wrench.



Figure 38 - Remove screw nut O-ring



Figure 39 - Remove washer retainer O-ring



Figure 40 - Remove belleville washer

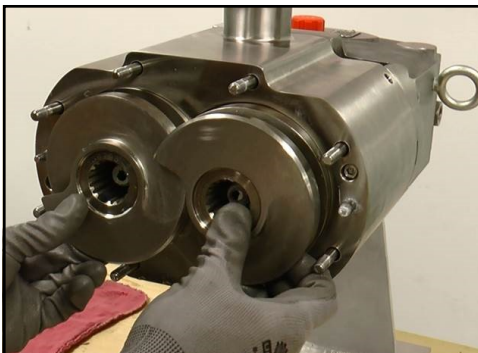

Figure 41 - Remove screws

Remove screws

1. Remove the screw nut O-ring from the outer O-ring groove on each screw nut as shown in Figure 38.
2. Remove the washer retainer O-ring from the inner O-ring groove on each screw nut as shown in Figure 39.
3. Remove the belleville washers from the screw nuts as shown in Figure 40. Inspect the washers and replace them if damaged.
4. Remove the screws simultaneously (030-UTS shown).

⚠ WARNING

The pump components and piping may contain sharp edges. Handle the screw screws carefully because edges may be sharp. Wear gloves while installing and servicing the pump to help avoid injuries from these hazards.

⚠ CAUTION

To lift the screws on the 130-UTS and 220-UTS, please have your maintenance department seek advice for safe lifting practices for objects weighing in excess of 40 lb (18 kg). The screw surfaces must be protected to maintain the 32 Ra surface finish for sanitary applications. It may be necessary to design or purchase a specialized lifting tool to cradle and lift the screws when meshed.

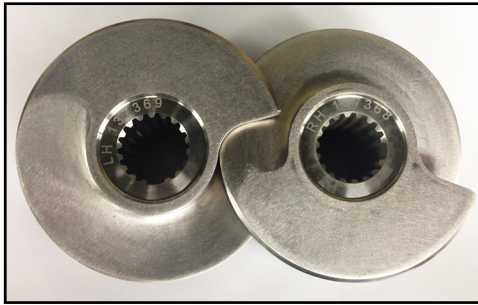

Figure 42 - Screws arranged LH - RH

5. Make note of which screw is the right-hand screw (marked RH), and which is the left-hand screw (marked LH), for later reassembly.

NOTE: The markings are on the front of the screw in the recessed area around the shaft spline hole. The SPX FLOW part number is also marked here; the smaller/lower part number goes on the right-hand side.



Figure 43 - Remove seal cap assembly

Remove seal cap and seal

1. Remove the seal cap assembly (seal cap and seal seat) from each shaft as shown in Figure 43.



Figure 44 - Remove seal seat from seal cap

2. Remove the seal seat from the seal cap and place it on a clean, protected surface as shown in Figure 44.



Figure 45 - Remove cap-to-screw O-ring

3. Remove the cap-to-screw O-ring from the smaller side (product side) of the seal cap as shown in Figure 45.



Figure 46 - Remove cap-to-seat O-ring

4. Remove the cap-to-seat O-ring from the larger side (flush side) of the seal cap as shown in Figure 46.

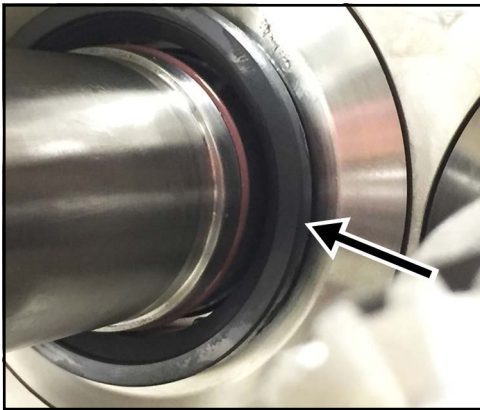

Figure 47 - Remove seal

Removing seal without removing body

NOTE: Steps 1-4 below are shown without removing the pump body. These steps can also be performed after the pump body is removed. To remove the seal after removing the pump body, skip to "Remove pump body" on page 38.

1. Remove the seal from each shaft.

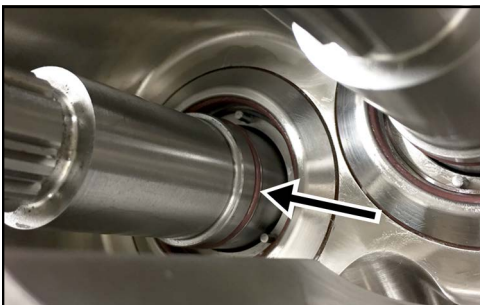

Figure 48 - Remove shaft O-ring

2. Remove the shaft O-ring from the O-ring groove on each shaft, as shown in Figure 48.



Figure 49 - Remove carrier-to-seal O-ring

3. Remove the carrier-to-seal O-ring from each shaft as shown in Figure 49. If necessary, use the O-ring removal tool (part number AD0096001) or an ice pick to aid in removing this O-ring.

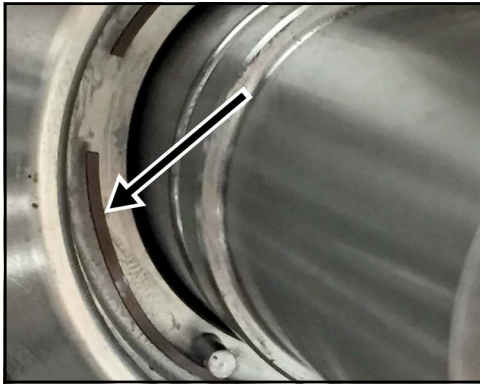

Figure 50 - Remove seal wave spring

4. Remove and inspect the seal wave spring on each shaft as shown in Figure 50.

Remove pump body

1. Using an Allen wrench, remove the two body retaining screws. (The body retaining screws are located next to the small dowel pins on the body. See the diagram on page 127. The body retaining screws are item 11.)

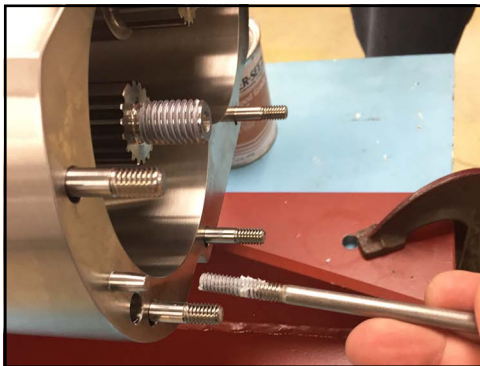

Figure 51 - Remove body retaining screws

2. Remove the pump body and place it on a protected surface as shown in Figure 52. When removing the pump body, be careful not to damage the seals with the shafts.

⚠ CAUTION

To lift the body of a 130-UTS, use a lifting strap or chain threaded through the eye bolt on the body.

⚠ CAUTION

To lift the body of a 220-UTS, use a lifting strap threaded through the vertical port on the body, and the front of the body (not through the shaft bores).

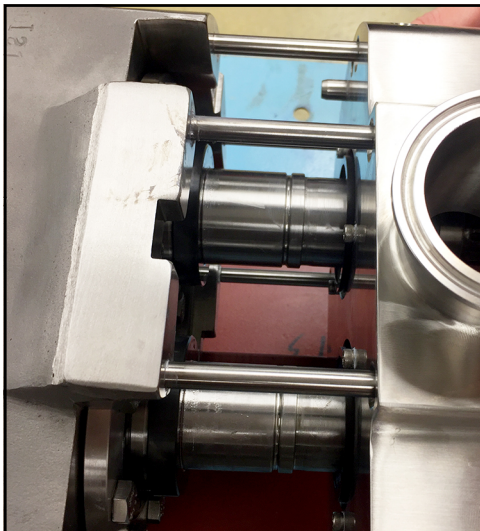
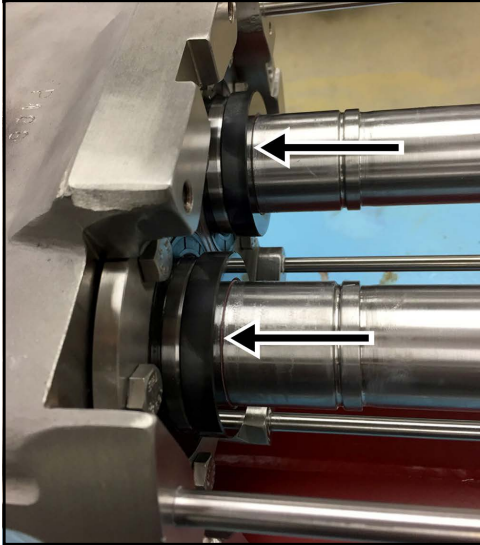
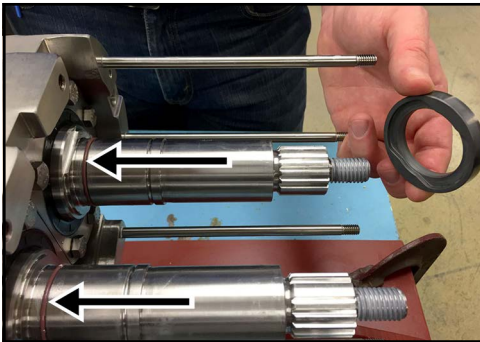

Figure 52 - Remove pump body

For a double seal, continue.

For a single seal, skip to step 1 on page 40.

Double seal - remove seals**Figure 53 - Remove seal seats****Figure 54 - Remove shaft O-rings****Figure 55 - Remove seal**

1. (Double seal only) Remove the seal seats from the shafts by hand. Pull the seal seats toward the end of the shafts. The arrows in Figure 53 show the seal seat location.
2. (Double seal only) After removing the seal seat, remove the shaft O-rings from the O-ring groove closest to the gear case as shown in Figure 54.
3. (Double seal only) Remove the seal from the seal carrier as shown in Figure 55, and place it on a clean, protected surface.

Single and double seal - remove seal carrier



Figure 56 - Remove cap screws

1. Using an Allen wrench, remove the three cap screws holding the seal carrier to the body as shown in Figure 56.

NOTE: It can be helpful to loosen the cap screws halfway and then lightly tap them with a hammer in order to help remove the seal carrier.

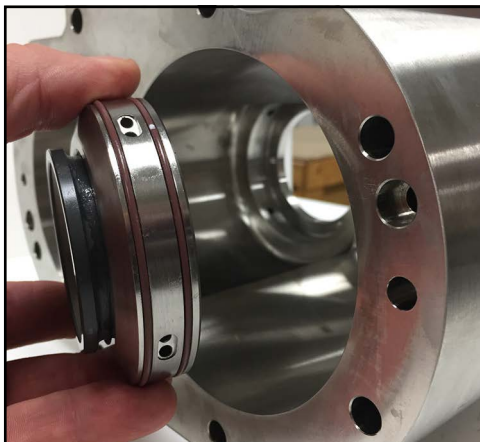

Figure 57 - Remove seal carrier from body

2. Remove the seal carrier from the body as shown in Figure 57.



Figure 58 - Remove seal

Removing seal after body is removed

1. Remove the seal from the product side of the seal carrier, and place it on a clean, protected surface as shown in Figure 58.

NOTE: The product side of the seal carrier has an angle and has no mounting holes.

NOTE: This step can also be performed with the body installed. See "Removing seal without removing body" on page 37.

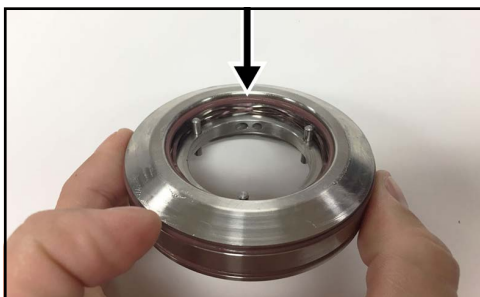

Figure 59 - Carrier-to-seal O-ring installed

2. Remove the carrier-to-seal O-ring from the product side of the seal carrier as shown in Figure 59.

NOTE: This step can also be performed with the body installed. See "Removing seal without removing body" on page 37.



Figure 60 - Seal wave spring

3. Remove the seal wave spring from the product side of the seal carrier.

For a single seal, skip to step 5.

For a double seal, continue.

NOTE: This step can also be performed with the body installed. See "Removing seal without removing body" on page 37.

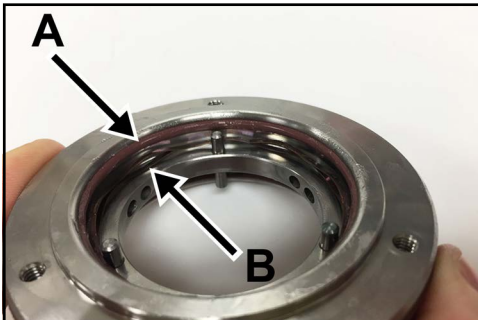

Figure 61 - O-ring and wave spring

4. For a double seal, remove the carrier-to-seal O-ring (A) and the seal wave spring (B) from the flush side of the seal carrier as shown in Figure 61.



Figure 62 - Carrier-to-body O-rings

5. Remove the carrier-to-body O-rings from the two grooves on the outside of the seal carrier as shown in Figure 62.

Remove Pump Body-Center, 3 Piece UTS030 and UTS130

NOTE: Before removing the pump body-center, for removing the cover, refer the page 32.

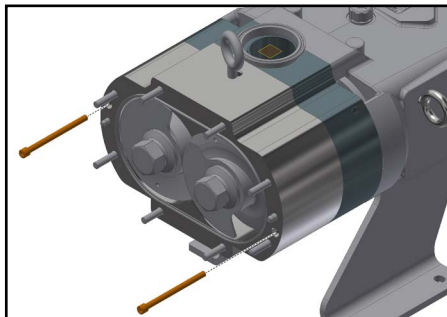

Figure 63 - Remove body-center retaining screws

1. Using an Allen wrench, remove the two body retaining screws (The body retaining screws are located next to the small dowel pins on the body as shown in Figure 63. See the diagram on page 143. The body retaining screws are item 11).
2. Remove the "pump body rotor side" and place it on a protected surface. When removing the pump body rotor side, be careful not to damage the seals with the shafts. If necessary, use a soft hammer to tap the body off the body studs and dowel pins.

CAUTION

To lift the body of a 130-UTS, use a lifting strap or chain threaded through the eye bolt on the body.

Remove Pump Body-Ported, 3 Piece UTS030 and UTS130

Before removing the pump body-ported, for removing the screw nuts and seals, refer from page 33 to page 38.

NOTE: The images are only for reference in the below procedure.



Figure 64 - Remove body retaining screws

1. Using an Allen wrench, remove the two body retaining screws. (The body retaining screws are located next to the small dowel pins on the body.)

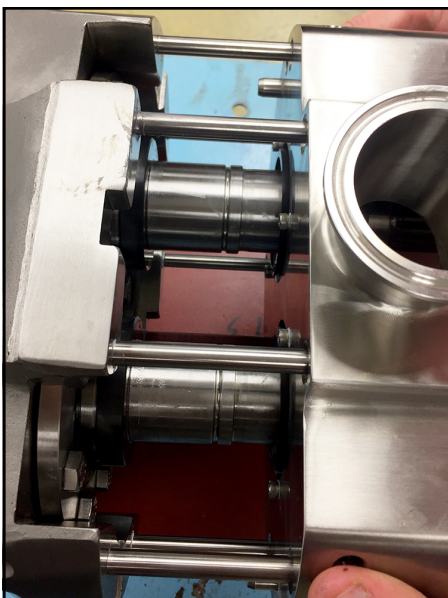

Figure 65 - Remove pump body-ported

2. Remove the pump body-ported and place it on a protected surface. When removing the pump body-ported, be careful not to damage the seals with the shafts.

CAUTION

To lift the body of a 130-UTS, use a lifting strap or chain threaded through the eye bolt on the body.

CAUTION

To lift the body of a 220-UTS, use a lifting strap threaded through the vertical port on the body, and the front of the body (not through the shaft bores).

For a double seal, continue.

For a single seal, skip to 1 on page 39

NOTE: After removing the pump body-ported, for removing the seal assembly, refer from page 38 to page 41.

Fluid Head Assembly

⚠️WARNING

The pump components and piping may contain sharp edges. Handle the screws carefully because edges may be sharp. Wear gloves while installing and servicing the pump to help avoid injuries from these hazards.

Seal assembly



Figure 66 - Seal Assembly Components

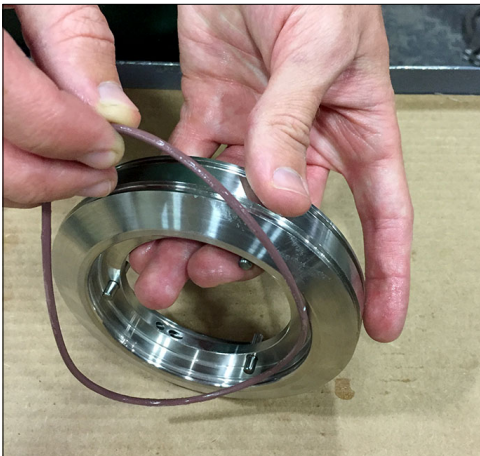

Figure 67 - Seal Carrier

1. Lubricate the carrier-to-body O-rings and install them onto the two grooves on the outside of the seal carrier as shown in Figure 67.



Figure 68 - O-rings installed

2. Figure 68 shows the carrier-to-body O-rings installed on the seal carrier.

Installing seals before installing body

NOTE: Steps 1-4, 7, and 8 can be performed after installing the body; see "Installing seals after the body is installed" on page 51.

1. Install the seal wave spring into the product side of the seal carrier as shown in Figure 69.

NOTE: The product side of the seal carrier has an angled surface and has no mounting holes.



Figure 69 - Seal wave spring

2. Figure 70 shows the seal wave spring installed in the seal carrier.

NOTE: Make sure the wave spring is positioned on the outside of the pins.



Figure 70 - Seal wave spring installed

NOTE: On the 015-UTS and 220-UTS, the wave spring is a single layer. Make sure that the gap in the wave spring is positioned between the pins as shown in Figure 71.

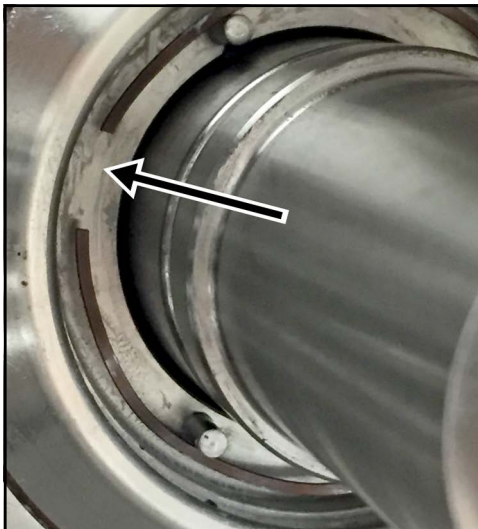

Figure 71 - Seal wave spring position

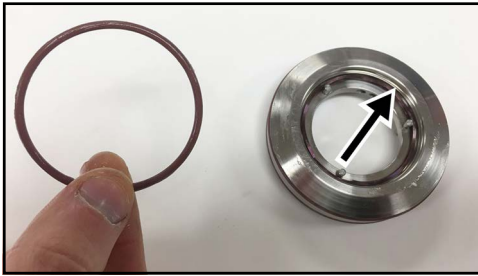

Figure 72 - Carrier-to-seal O-ring

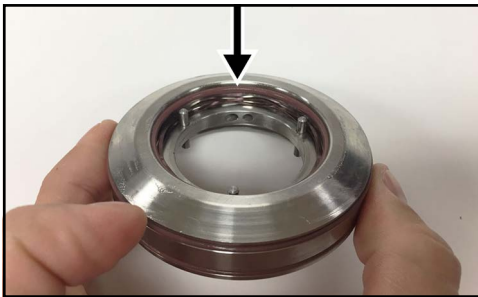

Figure 73 - Carrier-to-seal O-ring installed



Figure 74 - Seal wave spring installed



Figure 75 - Carrier-to-seal O-ring installed

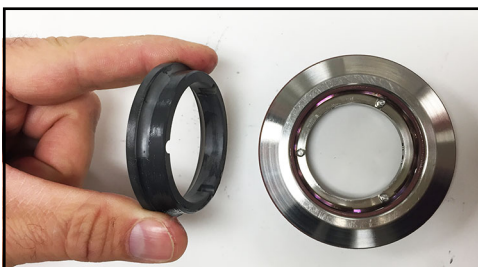

Figure 76 - Lubricate and install seal

- Lubricate the carrier-to-seal O-ring and install it in the groove on the inside of the seal carrier as shown in Figure 72.

This O-ring groove is located on the product side of the seal carrier.

NOTE: The product side of the seal carrier has an angled surface and has no mounting holes.

- Figure 73 shows the carrier-to-seal O-ring installed in the product side of the seal carrier.

For a single seal, skip to step 7.

For a double-seal, continue.

- For a double-seal, flip the seal carrier over and install the second seal wave spring on the flush side of the seal carrier as shown in Figure 74.

NOTE: On the 015-UTS and 220-UTS, the wave spring is a single layer. Make sure that the gap in the wave spring is positioned between the pins. See Figure 71 on page 44.

- (Double seal only) Lubricate and install the second carrier-to-seal O-ring in the flush side of the seal carrier as shown in Figure 75.

- Lubricate the outer diameter of the seal (see Figure 84 on page 47) and place it in the product side of the seal carrier. Align the slots in the seal with the pins in the seal carrier.



Figure 77 - Install seal

8. Make sure the slots in the seal align with the pins in the seal carrier, then press down evenly on all sides of the seal to install it in the seal carrier as shown in Figure 77.
9. Repeat steps 1 to 8 for the seal carrier for the other shaft.

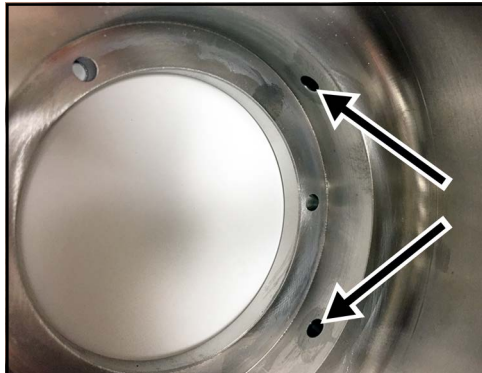

Figure 78 - View of flush holes on inside of pump body

10. The flush holes in the body are located toward the outside of the body (not toward the middle) as shown in Figure 78.

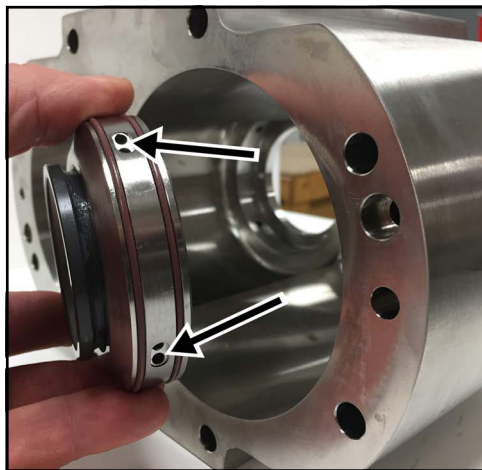

Figure 79 - Install seal carrier in body

11. Install the seal carrier into the body, making sure to line up the flush holes in the seal carrier with the flush holes in the body as shown in Figure 79.

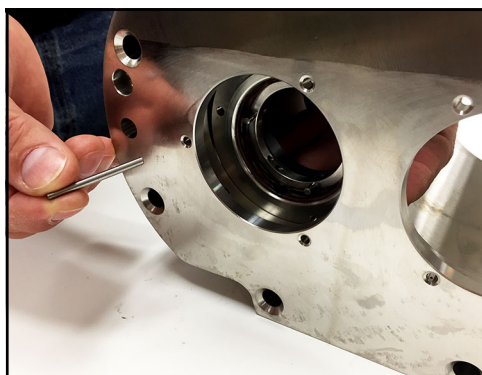

Figure 80 - Use drift pin to align holes

12. On the back side of the body, use an appropriately-sized drift pin to align the holes in the seal carrier with the holes in the body as shown in Figure 80.

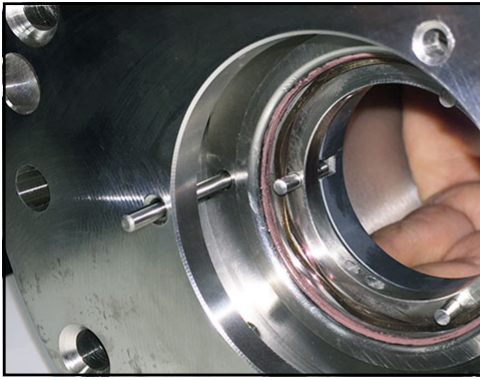

Figure 81 - Use drift pin to align holes



Figure 82 - Apply anti-seize



Figure 83 - Install with cap screws



Figure 84 - Lubricate the outer diameter of the seal

13. Figure 81 shows the drift pin aligning the holes in the seal carrier with the holes in the body. (Double seal shown.) Once aligned, remove the drift pin.

14. Apply anti-seize to the six socket head cap screws as shown in Figure 82.

15. Using an Allen wrench, install the seal carrier into the body with 3 cap screws as shown in Figure 83. Snug down the cap screws by hand, taking care not to over-tighten. (Double seal shown.)

16. Repeat to install the second seal carrier in the body.

For a single seal, skip to step 5 on page 49.

For a double seal, continue.

17. (Double seal only) Lubricate the outer diameter of the seal to ease assembly as shown in Figure 84. This seal is installed in the flush side of the seal carrier, from the back side of the body.



Figure 85 - Install seal

18. (Double seal only) Align the drive slots in the seal with the pins on the seal carrier, then press the seal into the carrier as shown in Figure 85.

NOTE: This may require a hard push, but use caution not to break the seal.

19. (Double seal only) Repeat steps 17 and 18 to install the seal in the second seal carrier.

Install pump body

For a single seal, skip to step 5 on page 49.

For a double seal, continue.



Figure 86 - Lubricate O-rings

1. (Double seal only) Lubricate two shaft O-rings as shown in Figure 86.

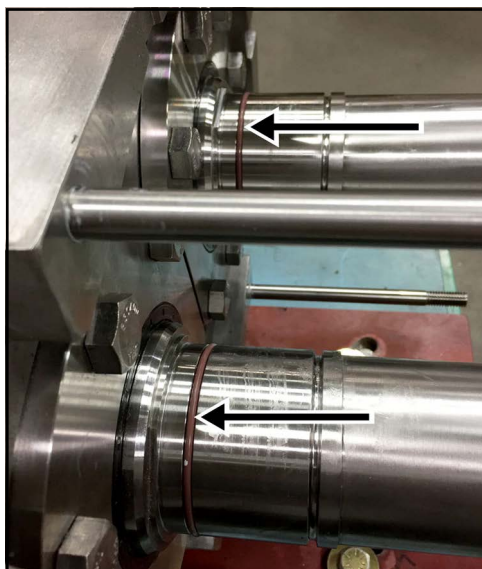

Figure 87 - Install shaft O-rings

2. (Double seal only) Install one O-ring on each shaft in the O-ring groove closest to the gear case, as shown in Figure 87.

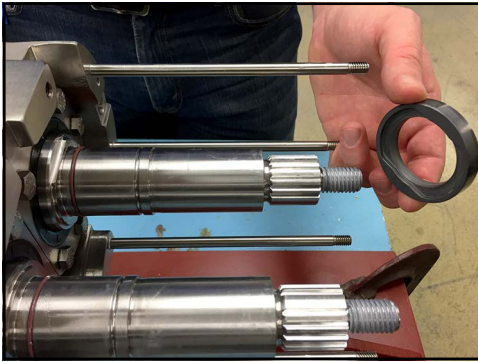

Figure 88 - Install seal seats

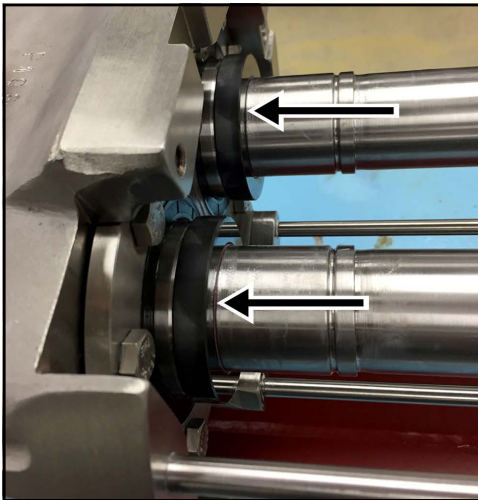

Figure 89 - Seal seats installed



Figure 90 - Install pump body onto shafts

3. (Double seal only) Line up the flats on the inside seal seat with the flats on the shaft as shown in Figure 88, and slide the seal seats over the O-ring, until they are seated against the base of the shaft.

4. (Double seal only) Make sure the seal seat is seated against the flats on the shaft, locking the seal seat against the base of the shaft. The arrows in Figure 89 show the seal seat location.

NOTE: These steps apply to both the single and double seal. Double seal is shown.

5. Use the studs to help center the pump body. Slide the pump body all the way on until it is seated against the gear case as shown in Figure 90.

NOTE: Be very careful not to damage the seals while installing the pump body on the shafts.

⚠ CAUTION

To lift the body of a 130-UTS, use a lifting strap or chain threaded through the eye bolt on the body.

⚠ CAUTION

To lift the body of a 220-UTS, use a lifting strap threaded through the vertical port on the body, and the front of the body (not through the shaft bores).

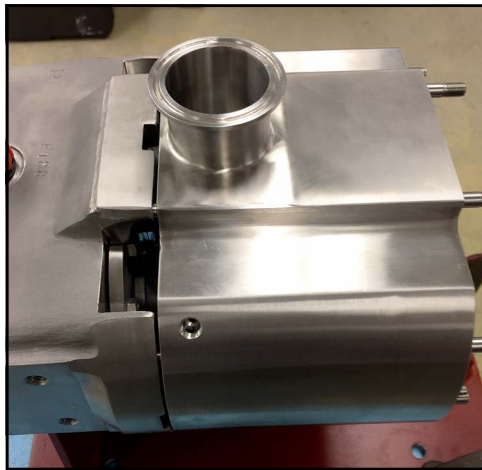

Figure 91 - Pump body installed

6. Figure 91 shows the pump body installed.



Figure 92 - Apply anti-seize to threads

7. Apply anti-seize to the threads of the body retaining screws as shown in Figure 92.

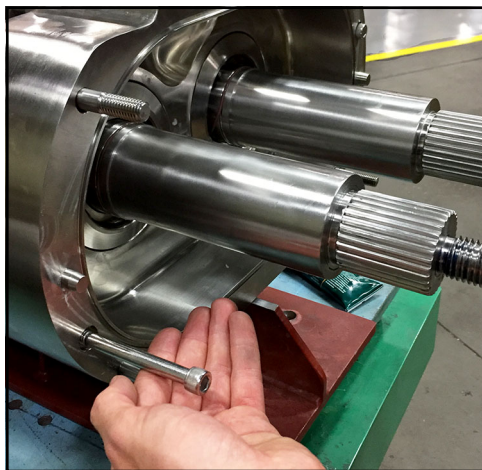

Figure 93 - Install body retaining screws

8. Using an Allen wrench, install the two body retaining screws in the holes next to the dowel pins, and hand-tighten. (220-UTS shown.)

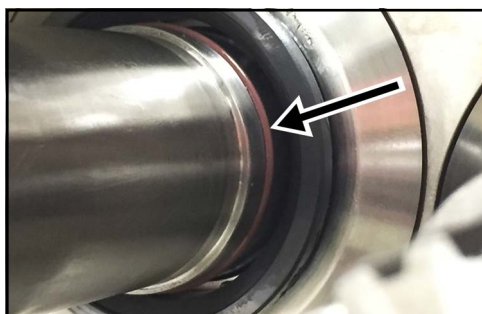

Figure 94 - Install shaft O-ring

9. If the seal has already been installed, lubricate the shaft O-ring, then slide the shaft O-ring over the shoulder in the shaft, and install it into the O-ring groove. See Figure 94. Repeat for the second shaft, then skip to “Seal cap assembly” on page 52.

Installing seals after the body is installed

1. Install the seal wave spring on each shaft as shown in Figure 95.

NOTE: On the 015-UTS and 220-UTS, the wave spring is a single layer. Make sure that the gap in the wave spring is positioned between the pins as shown in Figure 95.

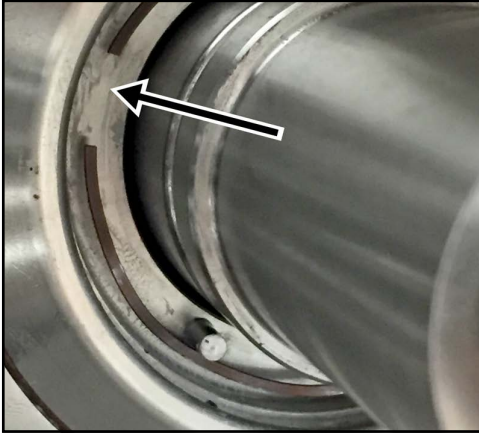

Figure 95 - Seal wave spring position

2. Lubricate the carrier-to-seal O-ring and install it in the groove on the inside of the seal carrier as shown in Figure 96.

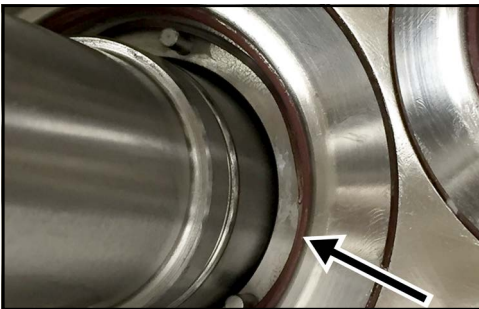

Figure 96 - Install carrier-to-seal O-ring

3. Lubricate the shaft O-ring. Slide the shaft O-ring over the shoulder in the shaft, and install it into the O-ring groove, as shown in Figure 97. Repeat for the second shaft.



Figure 97 - Install shaft O-ring

4. Align the drive slots in the seal with the pins on the seal carrier, then press the seal into the seal carrier as shown in Figure 98.

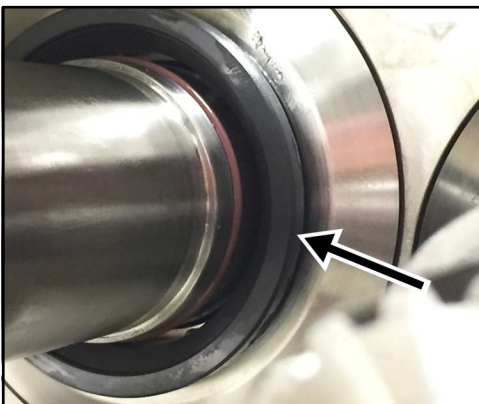

Figure 98 - Install seal

Seal cap assembly

Applies to both single and double seals.



Figure 99 - Seal Cap Assembly Components



Figure 100 - Install cap-to-seat O-ring



Figure 101 - Cap-to-seat O-ring installed



Figure 102 - Install cap-to-screw O-ring

1. Place the seal cap on a protected surface, making sure the side with the milled flats is facing up. Lubricate the cap-to-seat O-ring and install it on the seal cap as shown in Figure 100. Repeat for the second seal cap.
2. Figure 101 shows the cap-to-seat O-ring installed on the seal cap.
3. Lubricate and install the cap-to-screw O-ring on the opposite side of the seal cap (the side without the milled flats) as shown in Figure 102. Repeat for the second seal cap.

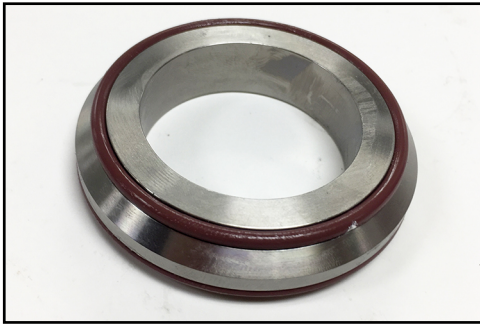

Figure 103 - Cap-to-screw O-ring installed

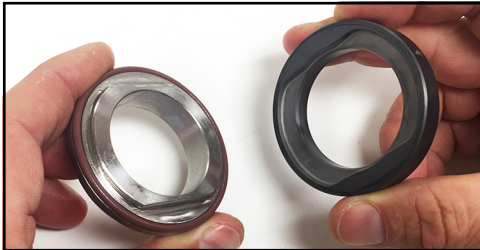

Figure 104 - Line up seal cap and seal seat



Figure 105 - Seal seat installed on seal cap

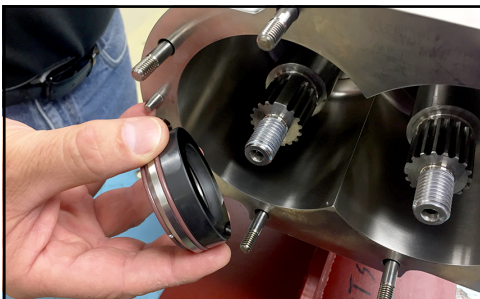

Figure 106 - Install seal cap assembly

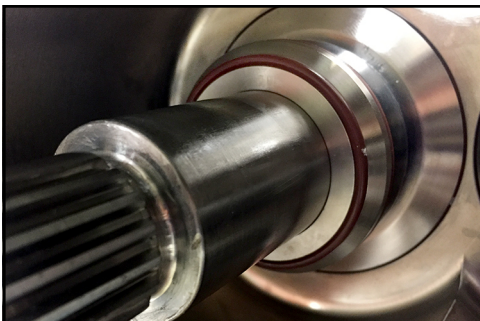

Figure 107 - Seal cap installed on shaft

4. Figure 103 shows the cap-to-screw O-ring installed on the seal cap.
5. Line up the flats on the seal cap, with the flats on the seal seat, and place the seal seat on the seal cap as shown in Figure 104.
6. Figure 105 shows the seal seat installed on the seal cap.
7. Install the seal cap assembly on the shaft. Make sure the face of the seal seat is seated against the face of the seal previously installed on the shaft as shown in Figure 106.
8. Figure 107 shows the seal cap assembly installed on the shaft. See the note next to Figure 108 on page 54.

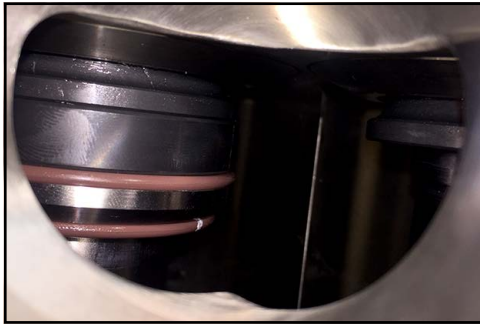

Figure 108 - View through port

NOTE: If the port is not connected to piping, look through it to visually confirm that all the O-rings and seal faces are installed correctly, as shown in Figure 108.

Install screws

⚠ WARNING

The pump components and piping may contain sharp edges. Handle the screws carefully because edges may be sharp. Wear gloves while installing and servicing the pump to help avoid injuries from these hazards.

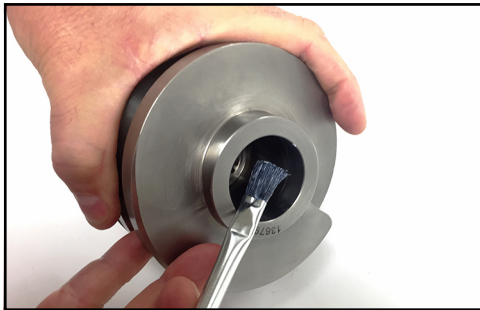

Figure 109 - Apply anti-seize

1. Apply anti-seize to the inner rim of the screw to ease assembly as shown in Figure 109.



Figure 110 - Arrange screws: LH-RH

2. Looking at the front of the pump, arrange the screws so the screw marked LH is on the left side, and the screw marked RH is on the right side, as shown in Figure 110.

NOTE: The markings are on the front of the screw in the recessed area around the shaft spline hole.

The SPX FLOW part number is also marked here; the smaller/lower part number goes on the right-hand side.

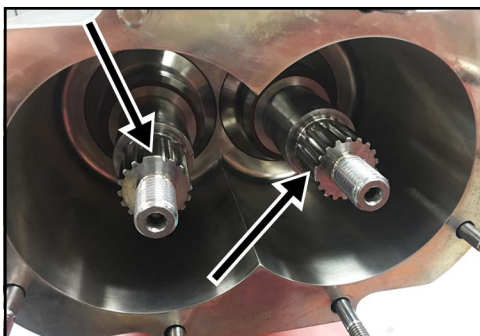

Figure 111 - Align screw and shaft spline

3. Look at the position of the indexing tooth on each shaft spline and roughly align the screw splines to match as shown in Figure 111.

⚠ CAUTION

To lift the screws on UTS pump models 130 and larger, please have your maintenance department seek advice for safe lifting practices for objects weighing in excess of 40 lb (18 kg). The rotor surfaces must be protected to maintain the 32 Ra surface finish for sanitary applications. It may be necessary to design or purchase a specialized lifting tool to cradle and lift the screws when meshed.

4. For 220-UTS, skip to step 7 on page 55.

For all other sizes, continue.

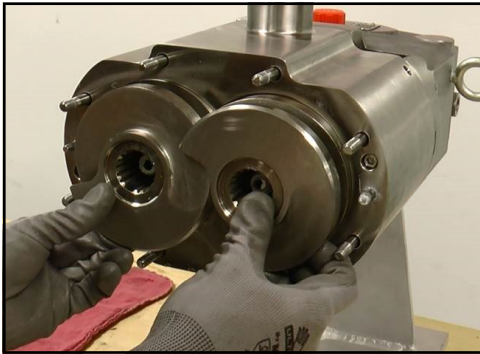

Figure 112 - Install screws

5. (All sizes except 220-UTS) Making sure each screw spline roughly matches the indexing tooth of each shaft spline (see arrows in Figure 111 on page 54), slide the screws onto the shafts as a pair, as shown in Figure 112.
6. (All sizes except 220-UTS) Once the beginning of the shaft spline meets the screw spline, make sure that the indexing teeth are lined up exactly. Lift up slightly on the screws, then push on the screws so that the splines engage. Push the screws onto the shafts completely, until they are flush with the edge of the seal caps.

⚠ WARNING

Pinch point: Be careful not to pinch your fingers between the screws and the pump body.

⚠ WARNING

The pump components and piping may contain sharp edges. Handle the screws carefully because edges may be sharp. Wear gloves while installing and servicing the pump to help avoid injuries from these hazards.

⚠ CAUTION

To lift the screws on the 130-UTS and 220-UTS, please have your maintenance department seek advice for safe lifting practices for objects weighing in excess of 40 lb (18 kg). The screw surfaces must be protected to maintain the 32 Ra surface finish for sanitary applications. It may be necessary to design or purchase a specialized lifting tool to cradle and lift the screws when meshed.

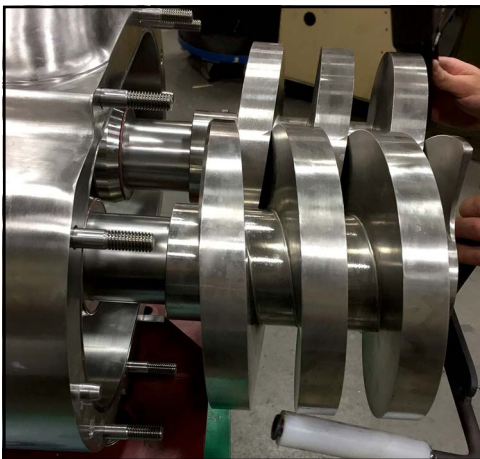

Figure 113 - Slide screws onto shafts

7. (220-UTS) Roughly line up the indexing teeth of the screw and shaft splines, then slide the screws onto the shafts as a pair. The screws will go on about halfway and then stop. At this point you can let the screws rest on the shafts, as shown in Figure 113.
8. (220-UTS) Lift up slightly on the screws, then slide them on, up to the splines. Make sure the indexing teeth are lined up exactly, then lift up slightly on the screws and push them on completely, until the screws are flush with the edge of the seal caps.

⚠ WARNING

Pinch point: Be careful not to pinch your fingers between the screws and the pump body.

⚠ WARNING

The pump components and piping may contain sharp edges. Handle the screw screws carefully because edges may be sharp. Wear gloves while installing and servicing the pump to help avoid injuries from these hazards.

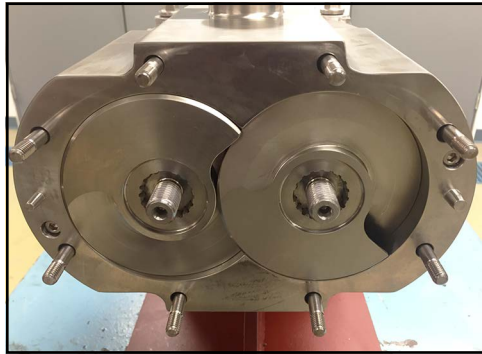

Figure 114 - Screws installed

9. Figure 114 shows the screws installed in the pump (030-UTS pictured).

Screw nut assembly

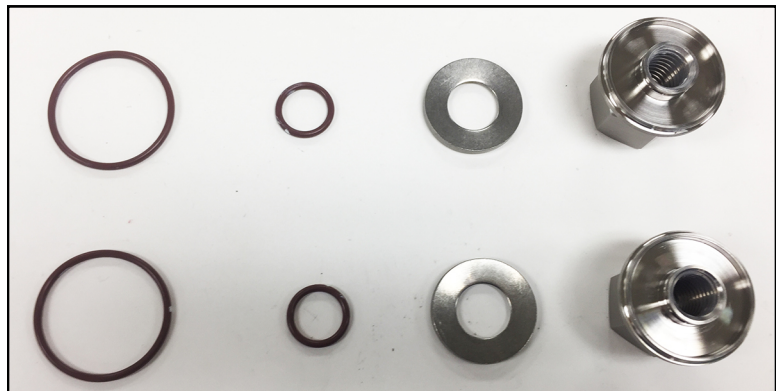

Figure 115 - Screw Nut Components



Figure 116 - Install belleville washer

1. Assemble the screw nuts: Place the belleville washer onto the screw nut. The belleville washer must be installed so the outer edge of the washer raises up over the edge of the screw nut as shown in Figure 116.



Figure 117 - Install washer retainer O-ring

2. Install the washer retainer O-ring onto the inner O-ring groove on the screw nut as shown in Figure 117.



Figure 118 - Belleville washer installed



Figure 119 - Install screw nut O-ring



Figure 120 - Screw nut assembly



Figure 121 - Apply anti-seize

3. Figure 118 shows the washer retainer O-ring and Belleville washer correctly installed. If the edge of the washer is lower than the edge of the nut, flip the washer over.
4. Install the screw nut O-ring onto the outer O-ring groove on the screw nut. Lubricate the O-ring as shown in Figure 119.
5. Figure 120 shows the Belleville washer and O-rings correctly installed.
6. Repeat for the second screw nut.
7. Apply anti-seize to the threads on the shafts as shown in Figure 121.

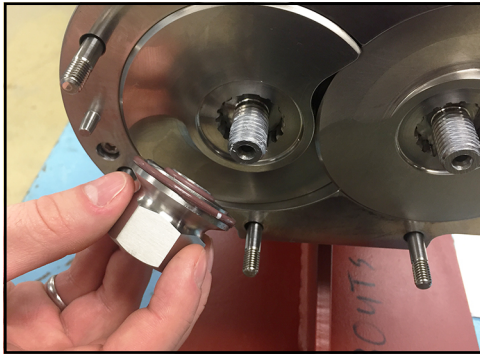

Figure 122 - Install screw nuts



Figure 123 - Direction of tool

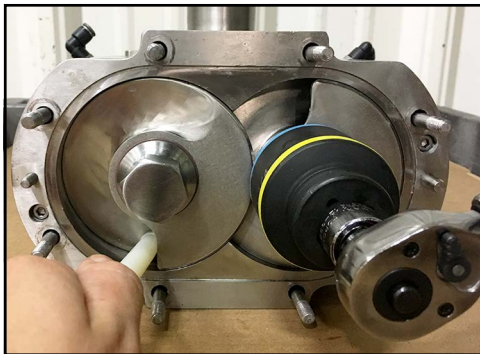

Figure 124 - Insert wedge

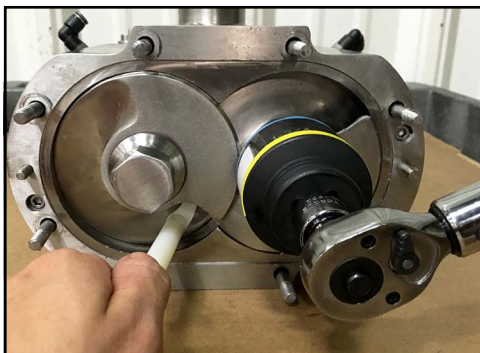

Figure 125 - Turn dowel

Installing screw nuts - all models except 220-UTS

NOTE: For 220-UTS, skip to page 59.

1. Install the screw nuts on the pump shafts and hand-tighten as shown in Figure 122.
2. For all models except the 220-UTS, arrange the Screw Nut Tool (part number 139883+) as shown in Figure 123, making sure the wedge curves upward to the right.
3. Turn the screws so that the end of the thread of the left-hand screw is lined up with the bottom of the body. Insert the wedge component of the assembly tool into the gap behind the left-hand screw thread as shown in Figure 124.
4. Turn the dowel counter-clockwise until the wedge is in contact with the screws. Begin to torque down the right-hand screw nut with the wrench. The wedge should begin to engage in between the outside diameter of the right-hand screw and root diameter of the left-hand screw. This prevents the screws from turning as shown in Figure 125.
5. With the wedge engaged, torque down the right-hand screw nut to the specification below.

Table 4: Torque Values - Screw Nut (015-130-UTS)

015-UTS	30 ft-lb (41 N·m)
030-UTS	55 ft-lb (68 N·m)
130-UTS	120 ft-lb (163 N·m)

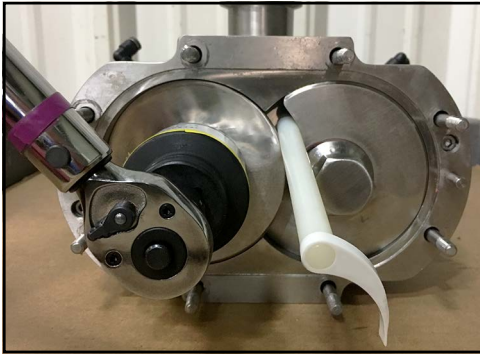

Figure 126 - Insert dowel

6. After the right-hand screw nut is torqued down, switch the wrench to the left-hand screw nut and turn clockwise. This will release the assembly tool as shown in Figure 126.
7. Turn the right-hand screw until the end of the thread of the right-hand screw lines up with the top.
8. Insert the screw nut tool in the gap between the right-hand screw thread and the outside diameter of the left-hand screw. This blocks the screws from turning.
9. With the wedge engaged, torque down the left-hand screw nut to the specification below.

Model	Torque
015-UTS	30 ft-lb (41 N·m)
030-UTS	55 ft-lb (68 N·m)
130-UTS	120 ft-lb (163 N·m)

10. Remove the screw nut tool and spin the pump over to confirm it rotates freely. If the pump does not spin over freely, fix the interference before starting the pump.

NOTE: To time the screws, see “Install Gears and Time Screws” on page 84.

To install the cover, skip to page 60.

Installing screw nuts - 220-UTS only



Figure 127 - Install screw nuts

1. Install and hand-tighten both screw nuts as shown in Figure 127.

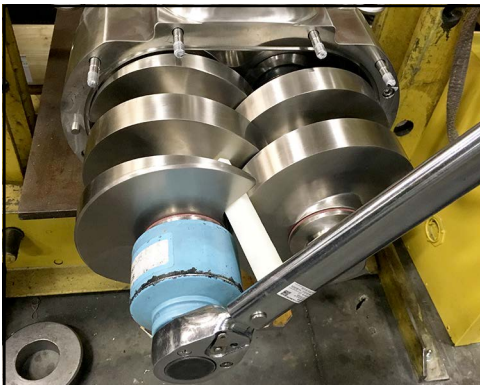

Figure 128 - Torque left screw nut

2. (220-UTS only) Turn the screws so that the end of the thread of the right-hand screw is lined up to the top. Insert the screw blocker (part number 139790+) into the gap behind the right-hand screw thread. With the block engaged, torque down the left-hand screw nut to 275 ft-lb (373 N·m).

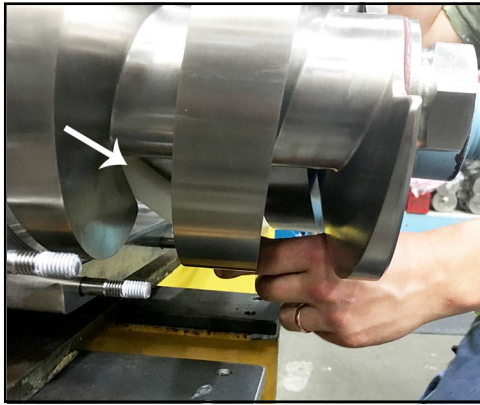

Figure 129 - Block right screw

- (220-UTS only) After tightening the left-hand screw nut, block the right-hand screw from the back of the screw as shown in Figure 129. Torque the right hand screw nut to 275 ft-lb (373 N·m).

NOTE: An alternate method to installing the right-hand screw nut: Use a wrench to secure both screw nuts simultaneously, then secure the coupling with a pipe wrench.

- Remove the screw blocker and spin the pump over to confirm it rotates freely. If the pump does not spin over freely, fix the interference before starting the pump.

NOTE: To time the screws, see “Install Gears and Time Screws” on page 84.

Install cover

- Install the cover gasket, flat side facing up, into the groove in the cover. (On the 220-UTS (not pictured), this gasket is installed in the groove on the body, not on the cover) as shown in Figure 130.

NOTE: It may be helpful to lubricate the cover gasket to help hold the gasket in place in the groove.

NOTE: For the 220-UTS, it may also be helpful to place four dots of lubricant at four spots in the groove, to help hold the gasket in place.

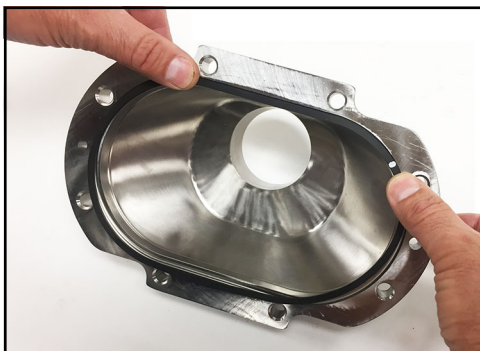

Figure 130 - Install cover gasket

- All sizes except 220-UTS: Align the cover holes with the lower cover studs, then slide the cover onto the pump as shown in Figure 131.

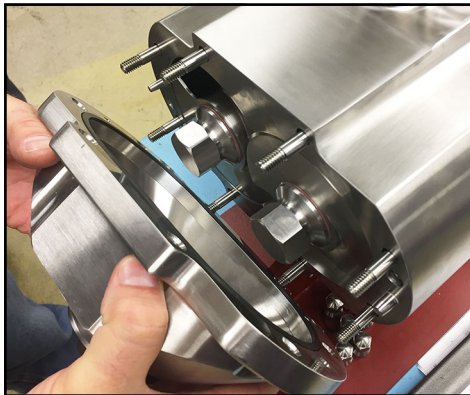

Figure 131 - Install pump cover

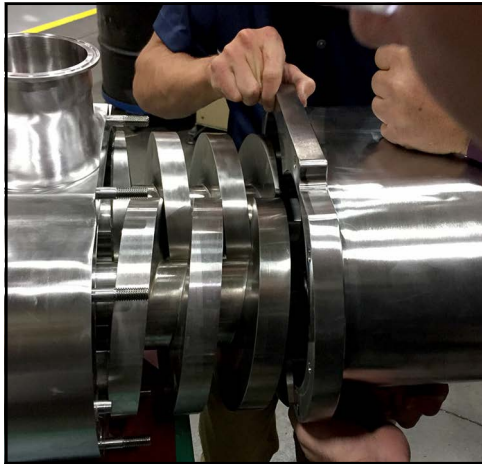

Figure 132 - 220 or 224-UTS Install pump cover

- 220-UTS only: Align the cover dowel pins with the holes in the cover, and slide the pump cover over the screws onto the pump.

⚠ CAUTION

To lift the cover on a 220-UTS, attach lifting straps or chains to the eye bolt.



Figure 133 - Seat pump cover against pump body

- Seat the pump cover against the pump body (220-UTS pictured) as shown in Figure 133.



Figure 134 - Apply anti-seize to threads

- Apply anti-seize to the threads of the cover studs as shown in Figure 134.



Figure 135 - Torque cover nuts

- Torque the cover nuts to the specified torque (see below).

Table 6: Torque Values - Cover Nut	
015-UTS	7 ft-lb (10 N·m)
030-UTS	11 ft-lb (15 N·m)
130-UTS	25 ft-lb (34 N·m)
220-UTS	55 ft-lb (75 N·m)

Install Pump Body-Ported, 3 Piece UTS030 and UTS130

For a single seal, skip to steps 1 to 1 on page 62 to 63

For a double seal, continue.

NOTE: Before installing the pump body-ported, for the seal assembly refer from page 43 to page 48.

NOTE: The images are only for reference in the below procedure.

1. (Double seal only) Lubricate two shaft O-rings as shown in Figure 136.



Figure 136 - Lubricate O-rings



Figure 137 - Install shaft O-rings

2. (Double seal only) Install one O-ring on each shaft in the O-ring groove closest to the gear case, as shown in Figure 137.

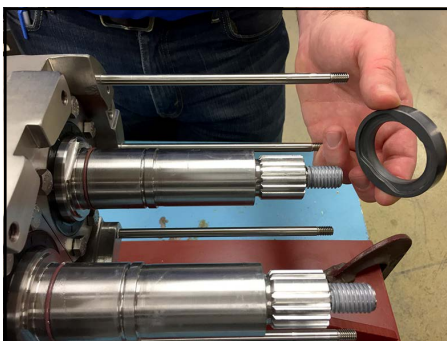

Figure 138 - Install seal seats

3. (Double seal only) Line up the flats on the inside seal seat with the flats on the shaft, and slide the seal seats over the O-ring, until they are seated against the base of the shaft as shown in Figure 138.

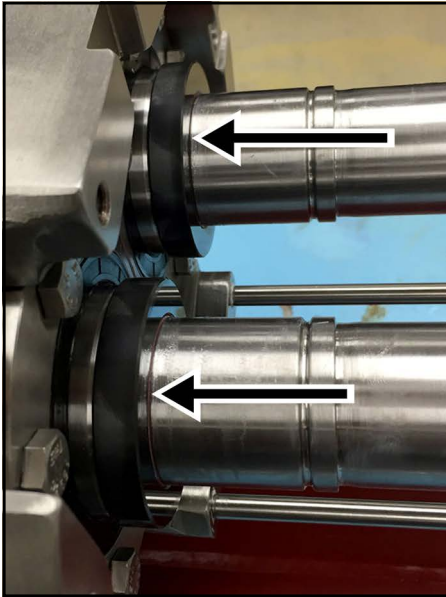

Figure 139 - Seal seats installed

4. (Double seal only) Make sure the seal seat is seated against the flats on the shaft, locking the seal seat against the base of the shaft. The arrows in Figure 139 show the seal seat location.

NOTE: These steps apply to both the single and double seal. Double seal is shown.



Figure 140 - -Install pump body onto shafts

5. Use the studs to help center the pump body-ported. Slide the pump body-ported all the way on until it is seated against the gear case as shown in Figure 140.

NOTE: Be very careful not to damage the seals while installing the pump body on the shafts.

⚠ CAUTION

To lift the body of a 130-UTS, use a lifting strap or chain threaded through the eye bolt on the body.

⚠ CAUTION

To lift the body of a 220-UTS, use a lifting strap threaded through the vertical port on the body, and the front of the body (not through the shaft bores).

6. Figure 141 shows the pump body-ported installed.

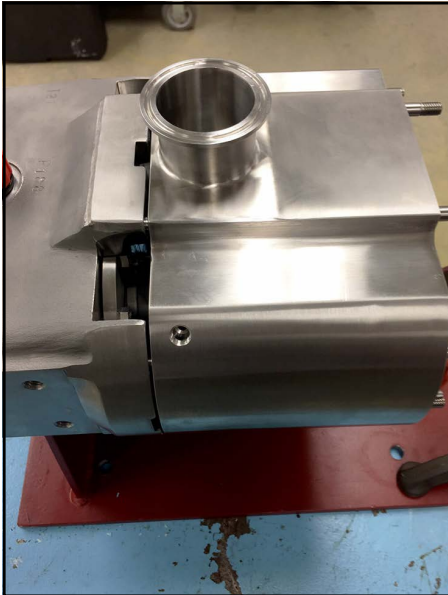

Figure 141 - Pump body-ported installed

7. Apply anti-seize to the threads of the body retaining screws as shown in Figure 142.



Figure 142 - Apply anti-seize to threads



Figure 143 - Install body retaining screws

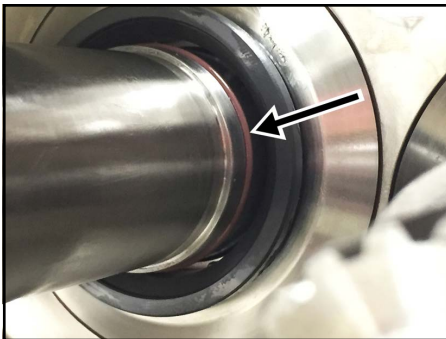

Figure 144 - Install shaft O-ring

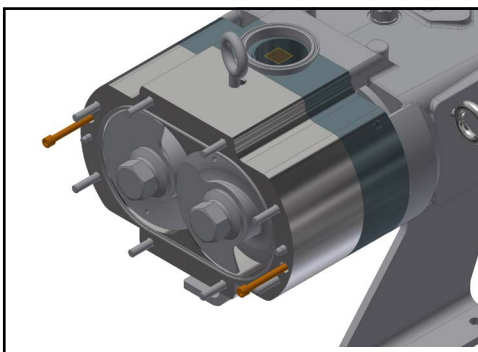

Figure 145 - Install pump body-center onto shafts

- Using an Allen wrench, install the two body retaining screws in the holes next to the dowel pins as shown in Figure 143, and hand-tighten. (220-UTS shown).

- If the seal has already been installed, lubricate the shaft O-ring, then slide the shaft O-ring over the shoulder in the shaft, and install it into the O-ring groove. See Figure 144. Repeat for the second shaft, then skip to "Seal cap assembly" on page 52.

Install Pump Body-Center, 3 Piece UTS030 and UTS130

NOTE: Before installing the pump body-center, to install the seals and screws, refer from page 51 to page 59

- Use the studs to help center the pump body. Slide the pump body rotor side all the way on until it is seated against the pump body port side as shown in Figure 145. See the diagram on page 143. The body retaining screws are item 11).

NOTE: When you install the pump body, be careful not to cause damage to the screws.

CAUTION

To lift the body of a 130-UTS, use a lifting strap or chain threaded through the eye bolt on the body.

- Apply anti-seize to the threads of the body-retaining screws.
- Using an Allen wrench, install the two body retaining screws in the holes next to the dowel pins and hand-tighten.

NOTE: After installing the pump body-center, to install the cover refer from page 60 to page 61.

Gear Case Disassembly

⚠ DANGER

To avoid serious injury, **DO NOT** install, clean, service, or repair the pump unless all power is off and locked out and the pump is de-pressurized.

⚠ DANGER

To avoid serious injury, shut off and drain product from the pump prior to disconnecting piping.

⚠ CAUTION

To lift the gear case assembly on the 130-UTS or 220-UTS, attach lifting straps/chains to the two eye bolts on either side of the gear case.

Remove oil drain plugs and cover

1. Remove one of the oil drain plugs (location shown in Figure 146, item 45) and drain the oil. Check the oil for signs for moisture; when contaminated with water, oil makes an emulsion similar to mayonnaise.

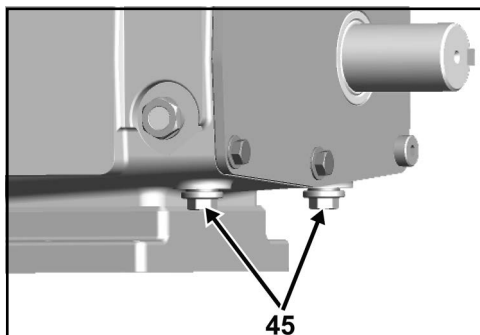

Figure 146 - Remove oil drain plug

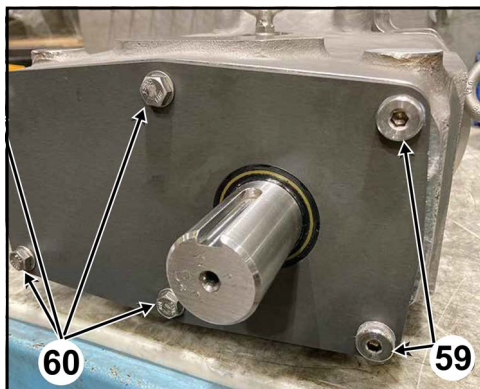

Figure 147 - Remove fasteners

2. Remove the fasteners from the gear case cover; the two socket head shoulder bolts (Figure 147, item 59) from the two holes by the drive shaft, and the four (six on the 220 and 224-UTS) hex head cap screws (item 60) from the remaining holes.

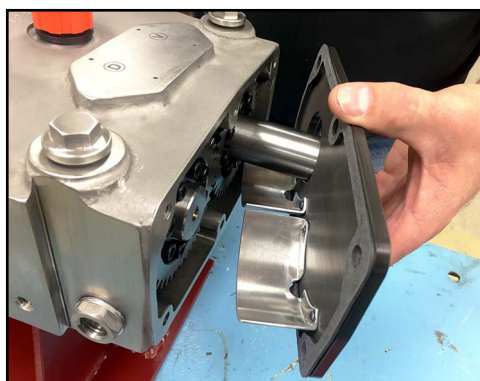

Figure 148 - Remove gear case cover

3. Remove the gear case cover. Discard the cover gasket as shown in Figure 148.

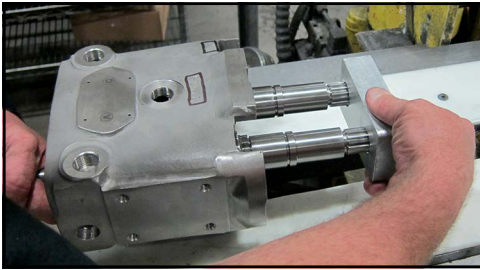

Figure 149 - Block shafts

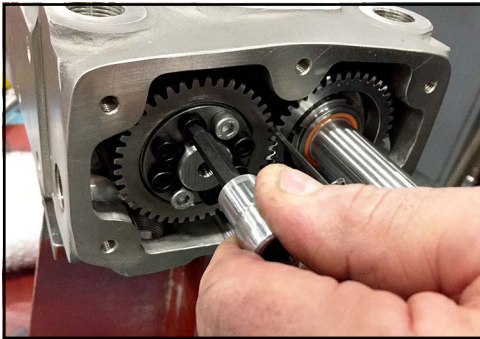

Figure 150 - Loosen bolts in locking assembly

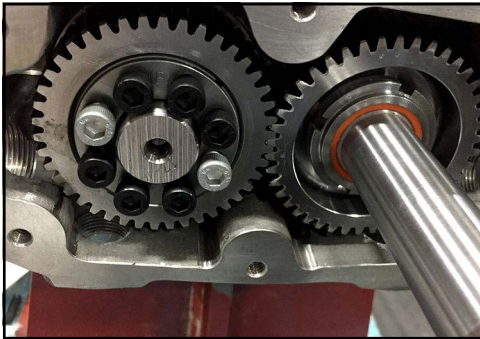

Figure 151 - Locking assembly

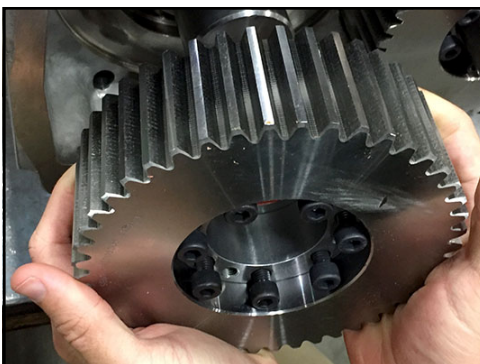

Figure 152 - Remove gear

Remove gear from short shaft

1. Block the shafts from turning as shown in Figure 149.
2. With an Allen wrench, loosen the screws in the locking assembly by quarter turns, until you can see a few threads as shown in Figure 150.
3. If the locking assembly does not self-release, tap the screws lightly with a mallet (or use thread jacking holes) to loosen the gear as shown in Figure 151.
4. Pull the gear and locking assembly off the shaft and place it on a protected surface as shown in Figure 152.

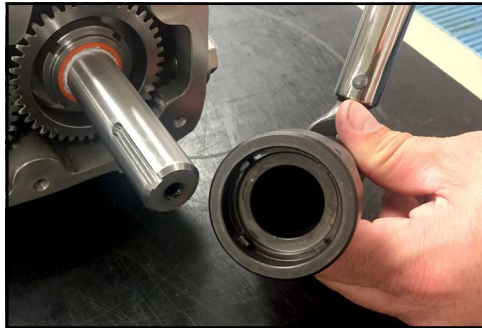

Figure 153 - Gear nut driver tool

Remove gear from drive shaft

1. Align the tabs on the socket of the gear nut driver tool (part numbers on page 151) with the indents on the locking nut as shown in Figure 153.



Figure 154 - Loosen locking nut

2. Loosen the locking nut as shown in Figure 154.



Figure 155 - Remove locking nut and gear

3. Remove the locking nut, gear & spacer from drive shaft.

NOTE: The locking nut is one-time use only; discard it after removal and replace it with a new locking nut when reassembling.

Remove shaft

1. Loosen and remove the bearing retainer bolts as shown in Figure 156.

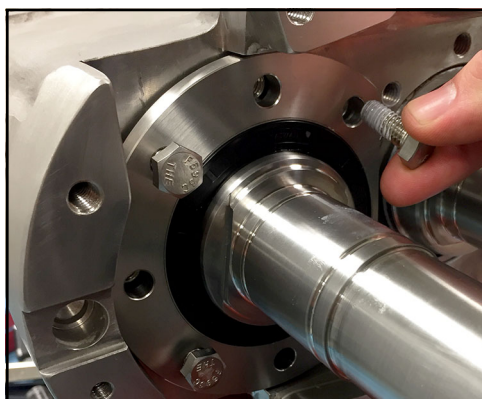

Figure 156 - Loosen and remove bearing retainer bolts

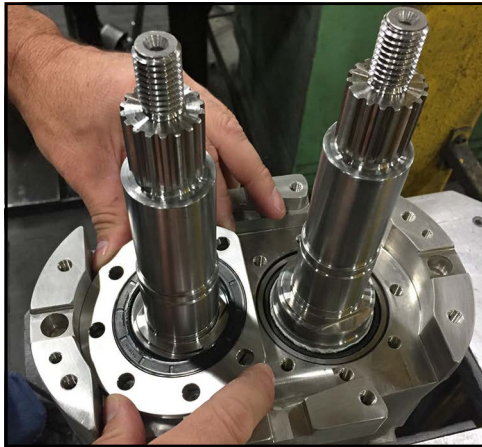

Figure 157 - Remove bearing retainer

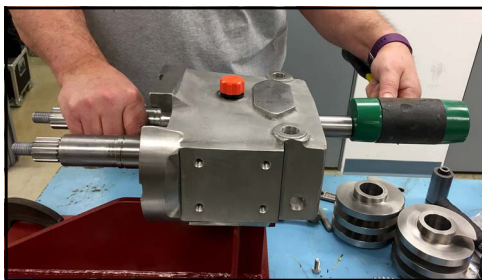

Figure 158 - Tap drive shaft out of gear case

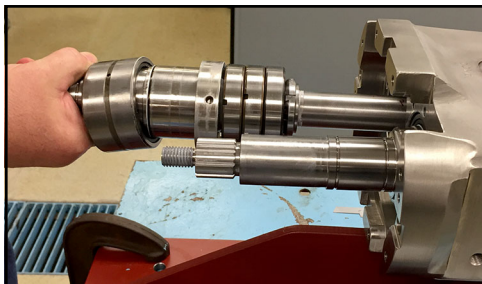

Figure 159 - Pull drive shaft out of gear case

2. Remove the bearing retainers as shown in Figure 157.

3. Grasp the shaft with one hand and tap it out of the gear case with a rubber mallet as shown in Figure 158.

NOTE: A hydraulic press may be required to remove the shafts.

4. Pull the drive shaft out of the gear case as shown in Figure 159.

⚠ CAUTION

To lift the shafts on the 220-UTS, please have your maintenance department seek advice for safe lifting practices for objects weighing in excess of 40 lb (18 kg).

NOTE: Repeat steps 3 and 4 for the short shaft removal.

Shaft disassembly

1. Before pressing, remove the outer race of the needle roller bearing.
2. Use a hydraulic press and V-blocks Figure 160, item A) to remove the bearings (items 1 and 2) and gear spacer (on drive shaft only, not shown).

NOTE: Make sure both ends of the shaft are protected when removing the shaft.

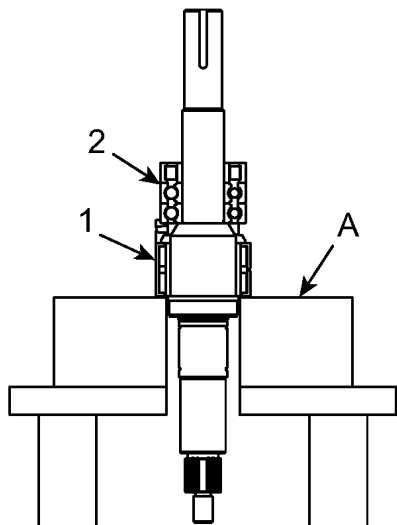

Figure 160 - Press bearings off shaft

Gear Case Assembly

⚠ DANGER

To avoid serious injury, DO NOT install, clean, service, or repair the pump unless all power is off and locked out. and the pump is de-pressurized.

⚠ DANGER

To avoid serious injury, shut off and drain product from the pump prior to disconnecting piping.

Shaft assembly

Shaft assembly components

Items needed, top, L-R in Figure 161 and Figure 162):

Needle roller bearing

Bearing spacer

Four point angular contact bearing

(x 2 per shaft, shown with plastic insert)

Cylindrical roller bearing

Figure 161, far right: Gear spacer

Figure 162, far right: Locking nut



Figure 161 - Drive Shaft: Assembly items needed



Figure 162 - Short Shaft: Assembly items needed



Figure 163 - Apply anti-seize

1. Apply a light coat of anti-seize to the circumference of the shaft as shown in Figure 163.

⚠ CAUTION

To lift the shafts on the 220-UTS, please have your maintenance department seek advice for safe lifting practices for objects weighing in excess of 40 lb (18 kg).

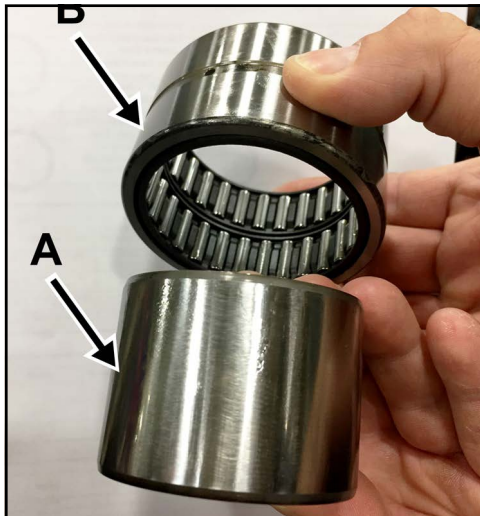

Figure 164 - Remove outer race of needle roller bearing

2. Remove the outer race (Figure 164, item B) of the needle roller bearing. (The inner race is item A.)



Figure 165 - Place inner race on shaft

3. Place the inner race of the needle roller bearing (Figure 165, item A) onto the shaft.

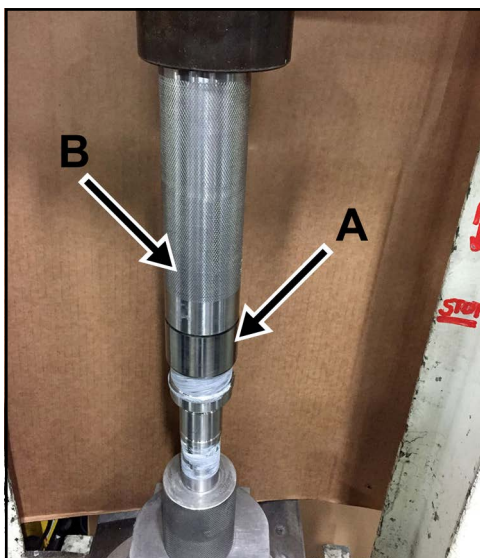

Figure 166 - Press race onto shaft

4. Press the inner race of the needle roller bearing (Figure 166, item A) onto the shaft as shown. Figure 166, item B is a bearing press assembly tool.

NOTE: The outer race of the needle roller bearing is installed later on page 80.



Figure 167 - Inner race installed on shaft

5. Press the inner race of the needle roller bearing onto the shaft until it seats against the lip of the shaft as shown in Figure 167.



Figure 168 - Place bearing spacer on shaft

6. Place the bearing spacer onto the shaft as shown in Figure 168.

NOTE: Make sure the angled side (see arrow) of the bearing spacer is facing down toward the needle roller bearing.



Figure 169 - Bearing spacer installed

7. Figure 169 shows the bearing spacer in place on the shaft.
NOTE: Make sure the flat side of the bearing spacer is facing up.

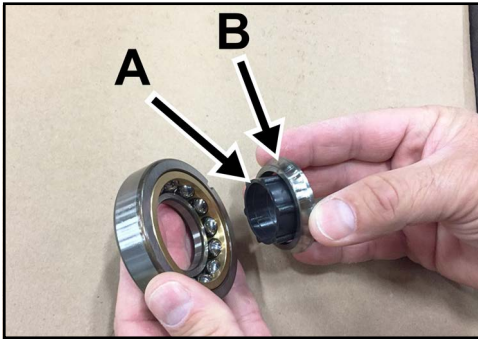

Figure 170 - Remove insert and race



Figure 171 - Remove bottom race



Figure 172 - Apply anti-seize to shaft



Figure 173 - Place race onto shaft

8. Remove the plastic insert (Figure 170, item A) and race (B) from one of the two four point angular contact bearings.

NOTE: There are two four point angular contact bearings per shaft, and two races per bearing. The races are installed on the shaft individually, so for ease of identification during assembly, keep the races paired with the bearings. When you remove the races, face them toward the side of the bearing from which they have been removed.

9. Remove the race from the other side of the four point angular contact bearing as shown in Figure 171.

NOTE: There are two four point angular contact bearings, so make sure the races remain in position in relation to each bearing. The smaller side of each race always faces in toward the ball bearings; the larger flanged side of each race always faces out.

10. Apply a light coat of anti-seize to the shaft as shown in Figure 172.

11. Place one race from the four point angular contact bearing onto the shaft. Note the position of the race. Make sure the flange faces down toward the shaft as shown in Figure 173.



Figure 174 - Press race onto shaft



Figure 175 - Race pressed on shaft



Figure 176 - Place bearing onto race

12. Press the race of the four point angular contact bearing onto the shaft. Make sure it seats against the step on the shaft as shown in Figure 174.

13. Figure 175 shows the race seated against the step on the shaft.

14. With the slot on the bearing facing down, place the four point angular contact bearing onto the race as shown in Figure 176.

NOTE: The slot location does not affect the function.



Figure 177 - Place race on shaft



Figure 178 - Race installed on shaft



Figure 179 - Place race on shaft



Figure 180 - Press race into bearing

15. Place the second race of the four point angular contact bearing onto the shaft. Note the position of the race. Make sure the narrower side of the race faces down toward the ball bearings, as shown in Figure 177.

16. Press the race into the bearing.

17. Figure 178 shows the four point angular contact bearing installed on the shaft.

18. Place the race of the next four point angular contact bearing onto the shaft. Note the position of the race. Make sure the flanged side of the race faces down toward the shaft, as shown in Figure 179.

19. Press the race of the next four point angular contact bearing onto the shaft as shown in Figure 180, until it seats against the angular contact bearing installed in step 17.



Figure 181 - Place bearing onto race

20. Place the four point angular contact bearing onto the race as shown in Figure 181.



Figure 182 - Place race on shaft

21. Place the second race of the four point angular contact bearing onto the shaft. Note the position of the race. Make sure the narrower side of the race faces down toward the ball bearings as shown in Figure 182.



Figure 183 - Press race into bearing

22. Press the race of the four point angular contact bearing onto the shaft, until it seats into the bearing as shown in Figure 183.



Figure 184 - Second bearing installed

23. Figure 184 shows the second four point angular contact bearing installed.
24. Apply anti-seize to the shaft.

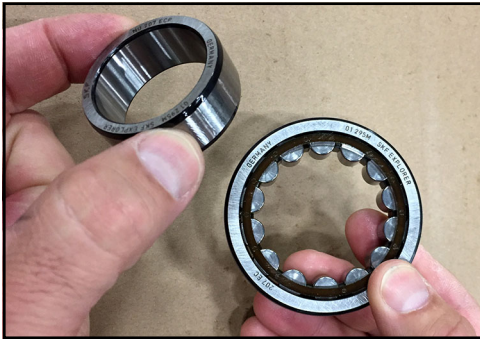

Figure 185 - Remove race from bearing



Figure 186 - Place race onto shaft



Figure 187 - Press race onto shaft



Figure 188 - Place bearing onto race

25. Remove the inner race of the cylindrical roller bearing Figure 185.

26. Place the inner race of the cylindrical roller bearing onto the shaft Figure 186.

27. Press the inner race of the cylindrical roller bearing onto the shaft until it contacts the four point angular contact bearing already installed as shown in Figure 187.

28. Place the outer race of the cylindrical roller bearing onto the inner race installed on the shaft as shown in Figure 188.

29. For the drive shaft, repeat steps 1 through 28, then skip to step 33. For the short shaft, continue.

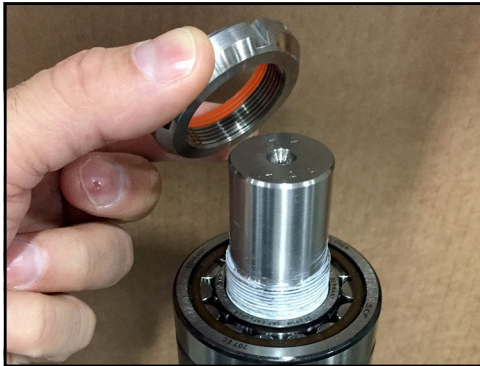

Figure 189 - Place locking nut onto shaft

30. Short shaft only: Apply anti-seize to the shaft. Place a new locking nut onto the shaft, and screw it on finger-tight as shown in Figure 189.



Figure 190 - Torque down locking nut

31. Short shaft only: Place the shaft in a holding device clamped into a vise, then torque down the locking nut onto the shaft.

Table 7: Torque Values - Locking Nut

015-UTS	75 ft-lb (102 N·m)
030-UTS	100 ft-lb (136 N·m)
130-UTS	140 ft-lb (190 N·m)
220-UTS	230 ft-lb (312 N·m)

CAUTION

To lift the shafts on the 220-UTS, please have your maintenance department seek advice for safe lifting practices for objects weighing in excess of 40 lb (18 kg).

32. Short shaft only: skip to “Install shafts in gear case” on page 79.

33. Drive shaft only: Press the gear spacer onto the shaft until it contacts the cylindrical roller bearing already installed as shown in Figure 191.

NOTE: Make sure the gear spacer is positioned so that the flanged side is up.

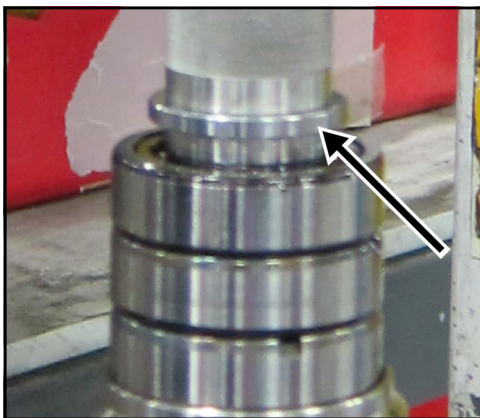

Figure 191 - Press gear spacer on drive shaft

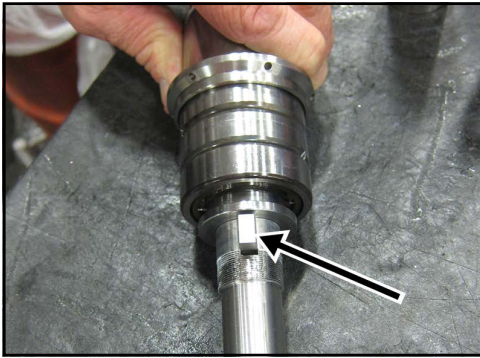

Figure 192 - Place key in keyway



Figure 193 - Tap key into keyway

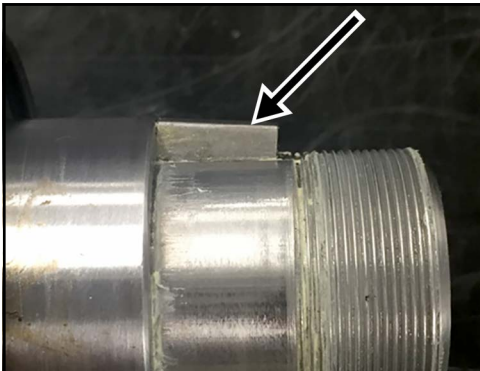

Figure 194 - Position key

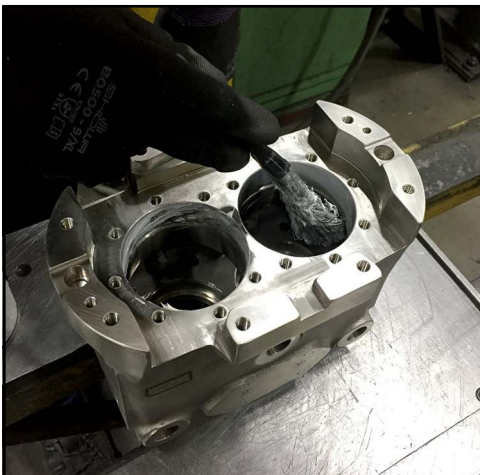

Figure 195 - Apply anti-seize

34. Drive shaft only: Place the key in the keyway on the shaft as shown in Figure 192.

35. Drive shaft only: Tap the key in with a hammer as shown in Figure 193.

36. Drive shaft only: Position the key so that it is angled down slightly toward the end of the shaft (toward the threads). This aids in installing the gear over the key as shown in Figure 194.

Install shafts in gear case

1. Place the gear case on an arbor press. Apply anti-seize to the lip of the shaft bores as shown in Figure 195.

⚠ CAUTION

To lift the gear case assembly on the 130-UTS or 220-UTS, attach lifting straps/chains to the two eye bolts on either side of the gear case.

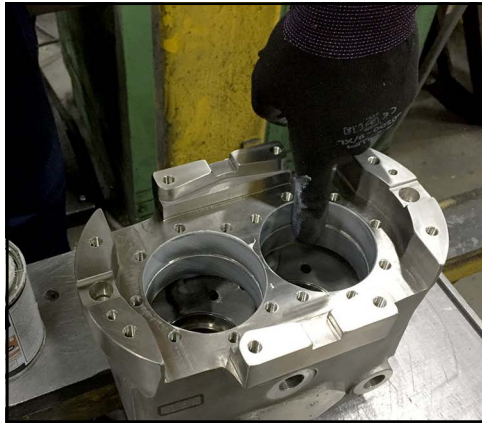

Figure 196 - Spread even layer

2. Rub a finger around the bore to spread the anti-seize in a thin, even layer around the inner lip of the bore as shown in Figure 196.

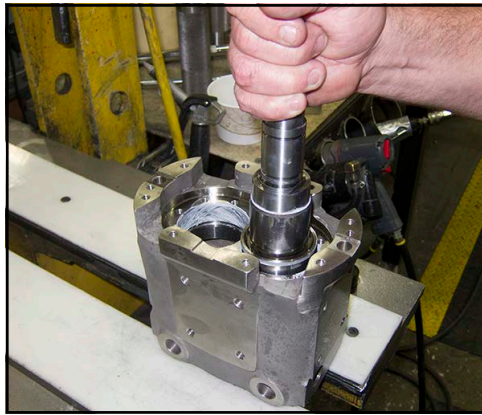

Figure 197 - Place short shaft in bore

3. Place the short shaft into the shaft bore, right-hand side as shown in Figure 197.

⚠ CAUTION

To lift the shafts on the 220-UTS, please have your maintenance department seek advice for safe lifting practices for objects weighing in excess of 40 lb (18 kg).

NOTE: In Figure 197, the gear case is positioned on end; the bottom of the gear case (with 4 holes for the mounting foot), facing toward the camera. The top of the gear case (the side with the nameplate and hole for the oil breather plug) is facing away from the camera.

NOTE: The UTS pump can only be mounted in one direction, so the shafts must be installed in the respective shaft bores as shown in Figure 197.



Figure 198 - Place outer race on shaft

4. Place the outer race of the needle roller bearing on the short shaft as shown in Figure 198.

NOTE: The inner race of the needle roller bearing was pressed onto the shaft in step 3 on page 71.



Figure 199 - Place drive shaft in bore

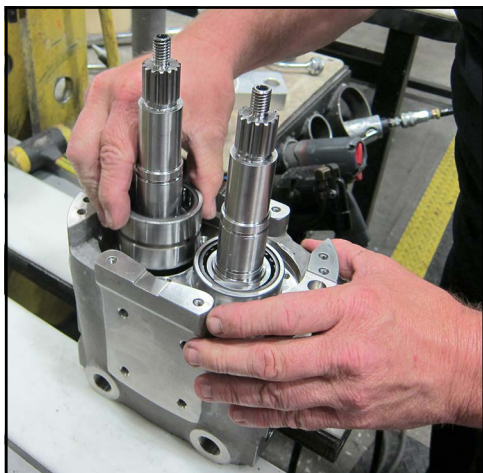

Figure 200 - Place outer race on shaft



Figure 201 - Tap shafts to center in bores

5. Place the drive shaft in the left-hand bore as shown in Figure 199.

⚠ CAUTION

To lift the shafts on the 220-UTS, please have your maintenance department seek advice for safe lifting practices for objects weighing in excess of 40 lb (18 kg).

6. Place the outer race of the needle roller bearing on the drive shaft as shown in Figure 200.

NOTE: *The inner race of the needle roller bearing was pressed onto the shaft in step 3 on page 71.*

7. Tap the shafts with a hammer to center them in the bores as shown in Figure 201.



Figure 202 - Shafts seated in gearcase

- Using a press, press on the outer race of each needle roller bearing until the outer bearing race seats in the gear case as shown in Figure 202.

Install Bearing Retainers

- Center the bearing retainer seal on the bearing retainer with the flat side of the seal facing up, as shown in Figure 203.



Figure 203 - Center bearing retainer seal

- Press to install the bearing retainer seal into the bearing retainer as shown in Figure 204.

⚠ CAUTION

Equal pressure is necessary for proper installation of the seal. Uneven installation may deform the seal and result in premature leaks.



Figure 204 - Install bearing retainer seal

- When correctly installed, the flat portion of the seal should be flush with the bearing retainer as shown in Figure 205.
- Repeat for the second bearing retainer.



Figure 205 - Bearing retainer seal installed

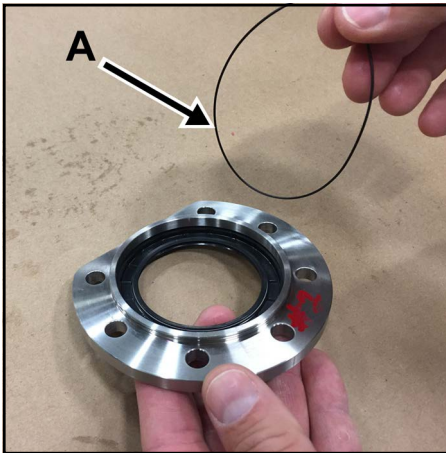

Figure 206 - Install bearing retainer O-ring

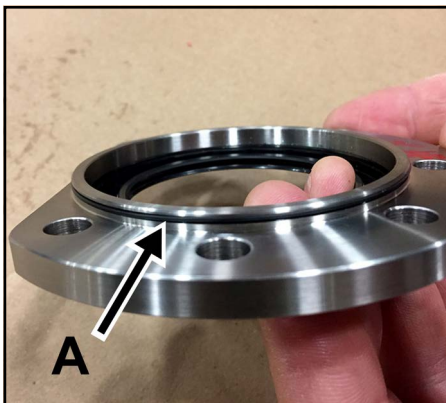

Figure 207 - Install bearing retainer O-ring

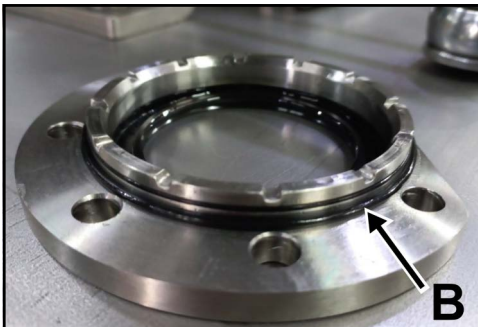

Figure 208 - Bearing retainer O-ring installed

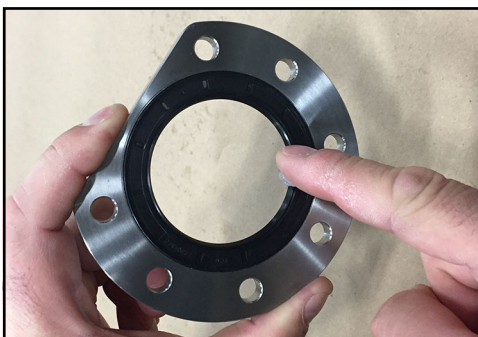

Figure 209 - Apply lubricant

5. Assemble the bearing retainer O-ring (item A) on the bearing retainer as shown in Figure 206.

6. Figure 207 shows the bearing retainer O-ring (item A) installed on the bearing retainer.

7. Assemble the bearing retainer 2nd O-ring (Figure 208, item B) on the bearing retainer.

8. Repeat for the second bearing retainer.

9. Apply lubricant between the lips of the bearing retainer seal as shown in Figure 209.



Figure 210 - Install bearing retainer

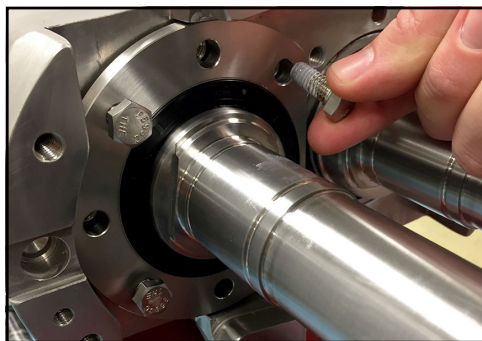

Figure 211 - Install screws

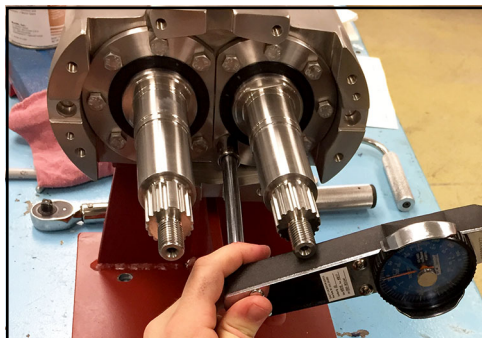

Figure 212 - Torque bearing retainer bolts

10. Install the bearing retainer on the shaft. Make sure the flat side of the bearing retainer faces the middle of the pump as shown in Figure 210.

11. Push one edge of the bearing retainer down, leaving the other side up, then apply pressure while slipping the other edge of the lip seal over the shaft.

NOTE: check to make sure that the lip seal did not roll during the installation.

12. Repeat for the second bearing retainer on the other shaft.

13. Apply anti-seize to the screws and install them in the bearing retainer as shown in Figure 211. Lightly snug down the screws by hand.

NOTE: Taking care with the O-ring awareness seat retainer on the shaft and against the bearing outer race within the gear case. Initially, finger tighten all bolts before torque verify the bearing retainer is parallel with the gear case face.

⚠ CAUTION

Never use powered tools to tighten or torque screws. Use hand tools only.

14. In an alternating pattern, torque the bearing retainer bolts by hand to the specified torque listed below.

Table 8: Torque Values - Bearing Retainer bolts	
015-UTS	24 in-lb (2 ft-lb) 3 N·m
030-UTS	84 in-lb (7 ft-lb) 9 N·m
130-UTS	180 in-lb (15 ft-lb) 20 N·m
220-UTS	300 in-lb (25 ft-lb) 34 N·m

Install Gears and Time Screws

Tools Required:

- Shim pack/Feeler gauge
- Allen socket
- Socket extension
- Torque wrench
- Marker.

Install gear on drive shaft

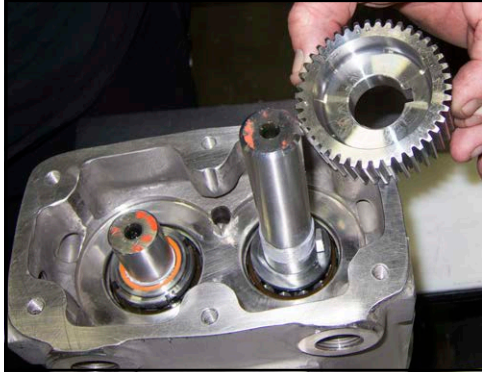

Figure 213 - Install drive gear



Figure 214 - Install drive gear



Figure 215 - Install locking nut



Figure 216 - Install locking nut

1. Install anti-seize on the threads of the shaft. Line up the notch in the drive gear with the key on the drive shaft. Make sure the flat side of the gear faces the gear case as shown in Figure 213.

2. Install the drive gear on the drive shaft as shown in Figure 214.

NOTE: A mallet and press tool may be used to make sure the gear is seated against the spacer.

3. Place the locking nut on the drive shaft, with the nylon ring facing up as shown in Figure 215.

4. Screw the locking nut on the drive shaft, hand-tight as shown in Figure 216.

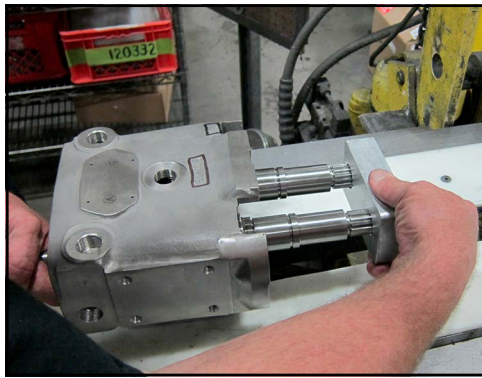

Figure 217 - Block shafts

5. Place the gear case upright, and block the shafts from turning. See "UTS Shaft Locking Tool" on page 154 for part numbers.



Figure 218 - Torque locking nut

6. Place the pump in a press (or use C-clamps) to keep it stationary as shown in Figure 218, and torque the locking nut to the values below.

Table 9: Torque Values - Locking Nut

015-UTS	15 ft-lb (20 N·m)
030-UTS	30 ft-lb (41 N·m)
130-UTS	45 ft-lb (61 N·m)
220-UTS	75 ft-lb (102 N·m)

Install plugs, sight glass, eye bolts

1. Install the oil breather plug into the hole in the gear case as shown in Figure 219.



Figure 219 - Install oil breather plug

2. Install the oil drain plug O-rings (part number N70114, item 46 on page 129) on the oil drain plugs, then install the drain plugs on the bottom of the pump as shown in Figure 220. Torque the plugs to 40 in-lb (4.5 N·m).

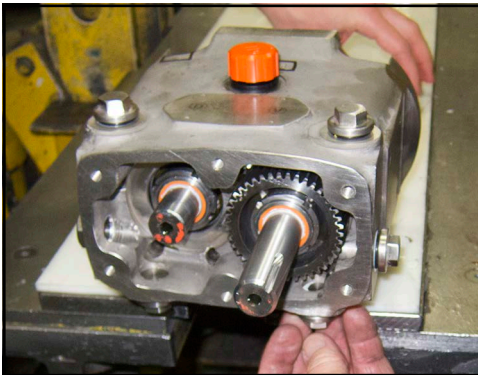

Figure 220 - Install plugs

3. Install the eye bolts (22) and sight glass (44) as shown in Figure 221.

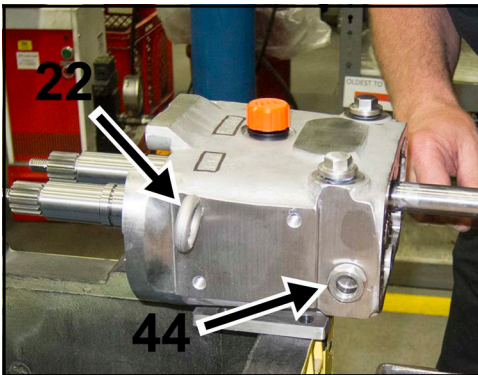

Figure 221 - Install sight glass and eye bolts

Install gear on short shaft

1. Inspect the locking assembly. If the locking assembly was exposed to gear lubricant, remove and clean the locking assembly.

To remove and clean the locking assembly:

- Remove the locking assembly and disassemble it by removing the bolts.
- Clean the parts, removing all oil residues.
- Spray the locking assembly components, including the bolts, with light oil.

NOTE: Do not use oils containing Molybdenum Disulfide.

- Re-assemble the locking assembly.

NOTE: The release threads of the inner ring must be positioned opposite to the un-drilled spaces of the outer ring.

2. Lubricate the locking assembly with light oil and place it in the gear.

NOTE: The bolts on the locking assembly must be loose and lightly oiled. Do not use any oil containing graphite.

NOTE: The gear shown in Figure 222 is from the 220-UTS. The short shaft gears on the 030-UTS and 130-UTS look similar to the 220-UTS, but the gear on the model 015-UTS has a flange in the center of the back of the gear.



Figure 222 - Assemble locking assembly into gear



Figure 223 - Place locking assembly into gear

3. Place the locking assembly into the gear so the back of the locking assembly is even with the back of the gear as shown in Figure 223.

NOTE: On the 015-UTS, the locking assembly seats against the flange.

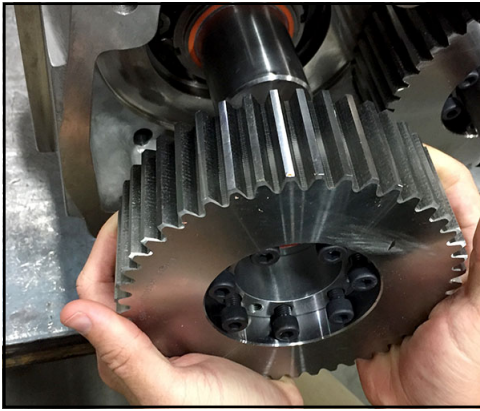

Figure 224 - Install gears onto pump shafts

4. Install the gear onto the pump shaft as shown in Figure 224. Push the gears back until the locking assembly is resting against the locking nut.

NOTE: On the 015-UTS, push the gears back until the back of the gear is resting against the locking nut.

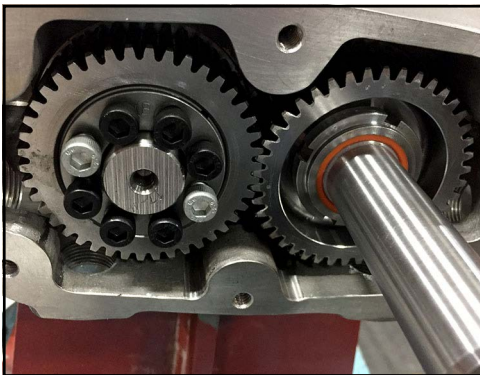

Figure 225 - Align loose gear with drive gear

5. Very lightly align the loose gear with the drive gear as shown in Figure 225.



Figure 226 - Install seal caps

Timing

1. Install the seal caps onto the shafts Figure 226.

NOTE: Make sure the flats on the seal cap are facing towards the gearcase.



Figure 227 - Install shafts

2. Install the screws onto the shafts Figure 227.

CAUTION

To lift the screws on the 130-UTS and 220-UTS, please have your maintenance department seek advice for safe lifting practices for objects weighing in excess of 40 lb (18 kg). The screw surfaces must be protected to maintain the 32 Ra surface finish for sanitary applications. It may be necessary to design or purchase a specialized lifting tool to cradle and lift the screws when meshed.

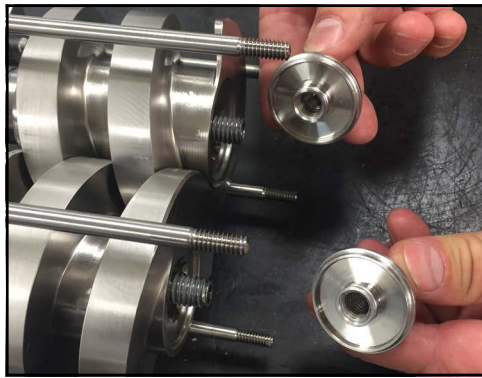

Figure 228 - Install screw nuts

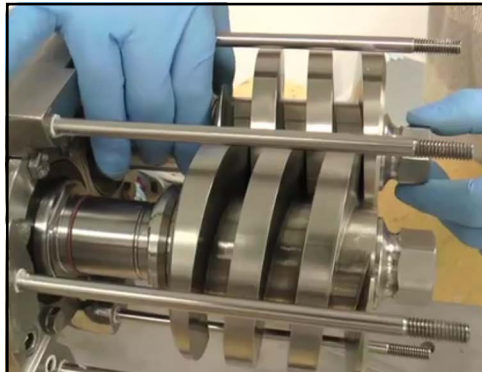

Figure 229 - Check seal caps



Figure 230 - Tighten screw nut



Figure 231 - Tighten screw nut

3. Install the screw nuts (without the O-rings or Belleville washers) as shown in Figure 228.

4. Tighten down the screw nuts by hand. Check to ensure that the seal caps are clamped down by the screws. If the seal caps can rotate without rotating the screws, adjust the position of the screws so that both seal caps are fully clamped down and unable to rotate. Finish by firming up the screw nuts with a wrench as shown in Figure 229.

5. Using the screw nut tool or screw blocking tool to keep the screw from turning, lightly tighten the screw nut as shown in Figure 230.

NOTE: Screw nut tool, part number 139883+, applies to all pumps except the 220-UTS. Screw blocking tool, part number 139790+, applies to the 220-UTS only. See "Screw Nut Tool" on page 154.

6. Block the other screw to keep it from turning, and lightly tighten the second screw nut as shown in Figure 231.

NOTE: Screw nut tool, part number 139883+, applies to all pumps except the 220-UTS. Screw blocking tool, part number 139790+, applies to the 220-UTS only. See "Screw Nut Tool" on page 154.

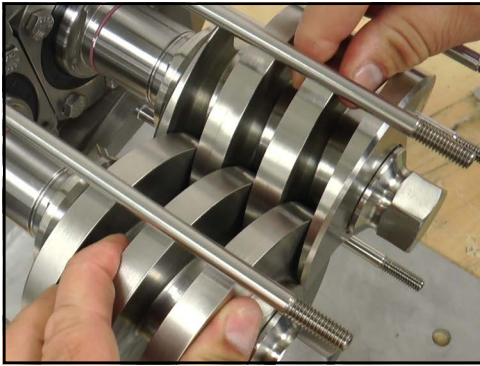

Figure 232 - Measure clearance

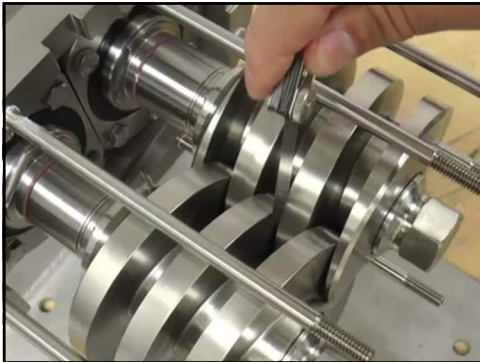

Figure 233 - Measure clearance

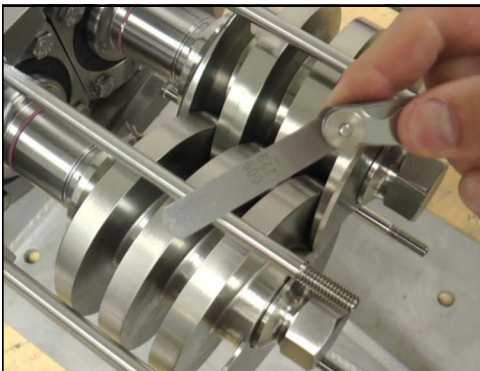

Figure 234 - Choose feeler gauge

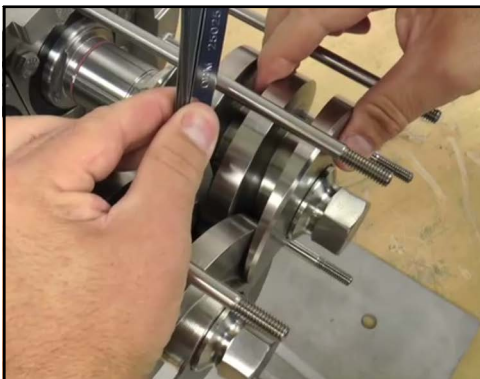

Figure 235 - Rotate screw

7. While holding the left screw in place, rotate the right screw clockwise until it contacts the other screw Figure 232.
8. With a feeler gauge, measure the open clearance between the screw flanks as shown in Figure 233.
9. Choose a feeler gauge that is equal to half the screw flank clearance measured in step 8.
10. Insert the feeler gauge selected in step 9 between the screw flanks. Holding the left screw in place, rotate the right screw counter-clockwise until it securely traps the feeler gauge between the screw flanks. This balances the flank-to-flank clearances as shown in Figure 235.

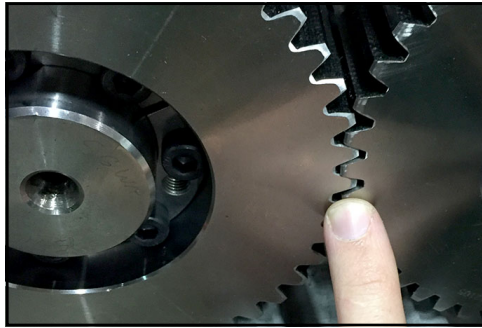

Figure 236 - Align gear

- Align the loose gear with the drive shaft gear as shown in Figure 236.

NOTE: It may be helpful to recess the loose gear slightly so that when it is tightened down and draws out, it aligns with the drive gear.

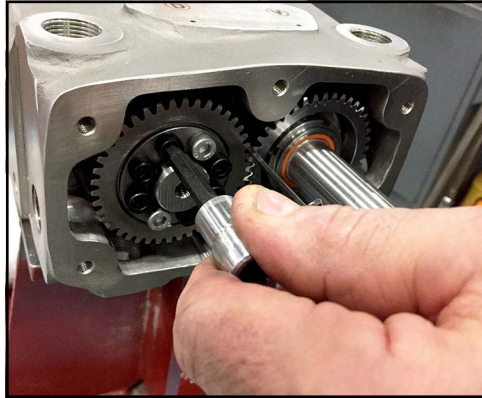

Figure 237 - Hand-tighten locking assembly bolts

- Place a soft dowel in the gear teeth to prevent the gears from turning.
- Hand-tighten the locking assembly bolts in an alternating pattern as shown in Figure 237.

NOTE: To keep the screws timed correctly, it is important to tighten the second gear to the shaft without rotating the shaft.

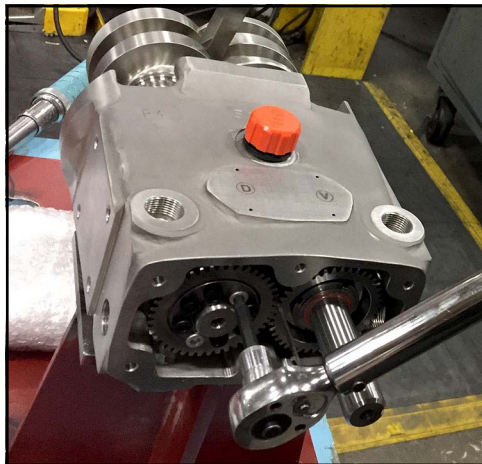

Figure 238 - Torque locking assembly bolts

- In an alternating pattern, torque the locking assembly bolts to half the specified torque, then to the full specified torque. See below.

Table 10: Locking Assembly				
Model	Screw Hex Size	Qty.	Half Torque	Full Torque
015-UTS	5 mm	8	63 in-lb 7 N·m	126 in-lb 14 N·m
030-UTS	5 mm	6	79 in-lb 9 N·m	158 in-lb 18 N·m
130-UTS 220-UTS	6 mm	6	189 in-lb 21 N·m	378 in-lb 43 N·m

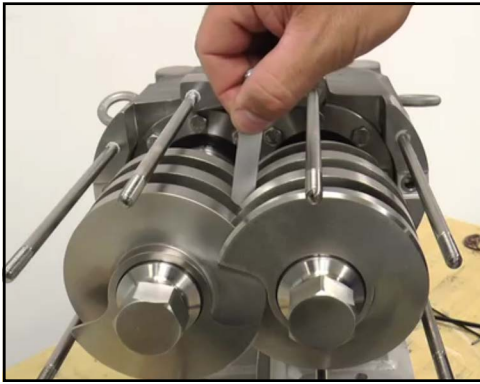

Figure 239 - Confirm the clearance

15. Confirm that the clearance between the screws is even on the front and back edges of the screw flanks. Turn the drive shaft and ensure that there is no contact at any point. If necessary, re-time the screws as shown in Figure 239.



Figure 240 - Gear case cover components

Assemble and install gear case cover

1. Place the gear case cover on a protected surface, with the inner face, facing up, as shown in Figure 240.



Figure 241 - Align screw holes

2. Align the holes in the left hand gear shroud (see note below) with the holes in the gear case cover as shown in Figure 241.

NOTE: On the 015-UTS, there is a right and a left gear shroud. On all other sizes, the two shrouds are identical.



Figure 242 - Apply Loctite®

3. Apply Loctite® 242 or equivalent to the shroud screws, and insert them in the holes in the shroud as shown in Figure 242.

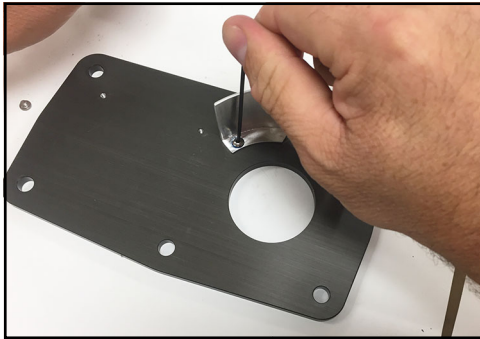

Figure 243 - Tighten shroud screws



Figure 244 - Shrouds installed



Figure 245 - Place gasket on cover

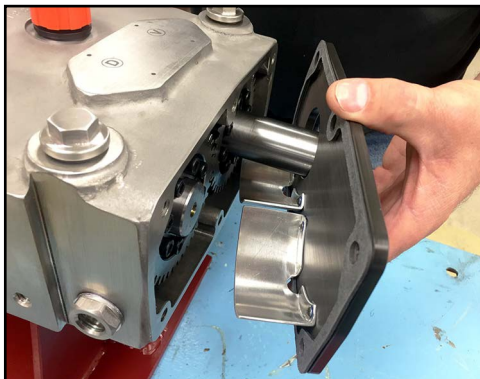

Figure 246 - Install gear case cover

4. With an Allen wrench, tighten the shroud screws till snug as shown in Figure 243.
5. Repeat for the second shroud. Figure 244 shows the shrouds installed.
6. Place the gear case cover gasket on the gear case cover as shown in Figure 245, aligning the holes in the gasket with the holes in the cover.
NOTE: *The gear case cover gasket is designed to compress when the back cover bolts are torqued. If you are re-installing a back cover that has previously been torqued down, replace the gear case cover gasket.*
7. Install the gear case cover on the gear case. Slide the shrouds under the gears and the drive shaft hole over the drive shaft. Make sure the gears do not contact the gear shrouds when the cover is in place as shown in Figure 246.

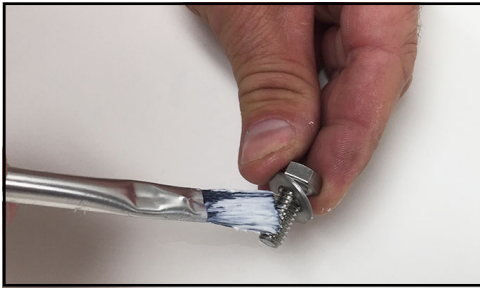

Figure 247 - Apply anti-seize

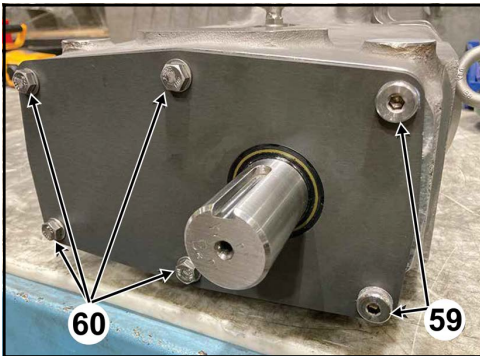

Figure 248 - Install fasteners

8. Add washers, then apply anti-seize to the gear case cover fasteners as shown in Figure 247.

NOTE: The two socket head shoulder bolts do not have washers.

9. Install the two socket head shoulder bolts (Figure 248, item 59) in the two holes by the drive shaft, and the hex head cap screws (item 60) in the remaining holes. Snug down the bolts/screws by hand. (There are four hex head cap screws on all but the 220-UTS; six on the 220-UTS.)

10. Before torquing the bolts/screws, turn the drive shaft and ensure that the gears do not contact the gear shrouds.

NOTE: If there is contact, remove the cover and shift the shrouds as low on the cover as the shroud screw holes allow.

11. Torque the fasteners in an alternating pattern as specified in Table 11.

Table 11: Torque Values - Gear Case Cover		
Model	HHCS, item 60	SHSB, item 59
015-UTS	88 in-lb (10 N·m)	110 in-lb (12 N·m)
030-UTS	110 in-lb (12 N·m)	132 in-lb (15 N·m)
130-UTS, 220-UTS	132 in-lb (15 N·m)	176 in-lb (20 N·m)



Figure 249 - Install oil seal

12. On the inner diameter of the oil seal, apply lubricant between the lips of the seal.

13. Install the oil seal on the drive shaft Figure 249.



Figure 250 - Oil seal installed

14. Press the oil seal into the gear case cover, flush with the outside face Figure 250.

Gear Case Disassembly Of UTS PLUS

⚠ DANGER

To avoid serious injury, DO NOT install, clean, service, or repair the pump unless all power is off and locked out and the pump is de-pressurized.

⚠ DANGER

To avoid serious injury, shut off and drain product from the pump prior to disconnecting piping.

⚠ CAUTION

To lift the gear case assembly on the 130-UTS attach lifting straps/chains to the two eye bolts on either side of the gear case.

NOTE: This section applies for UTS PLUS version Gear Cases ONLY.

UTS PLUS Gear Cases have unique parts & maintenance instructions. Specific Parts are not to be interchanged between Gear Case versions.

Follow Installation/Disassembly Instructions Carefully for UTS PLUS Version.

NOTE: UTS PLUS is available in 030 & 130 sizes only.

NOTE: Identify & Verify Gear Case Version.

UTS PLUS Gear Cases have cast-in 'PLUS' symbol at top as shown in Figure 251.



Figure 251 - PLUS' symbol

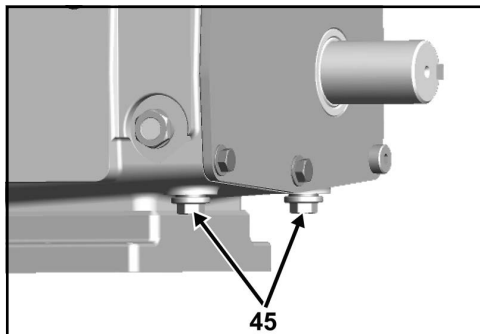

Figure 252 - Remove oil drain plug

Remove oil drain plugs and cover

1. Remove one of the oil drain plugs (location shown in Figure 252, item 45) and drain the oil. Check the oil for signs for moisture; when contaminated with water, oil makes an emulsion similar to mayonnaise.

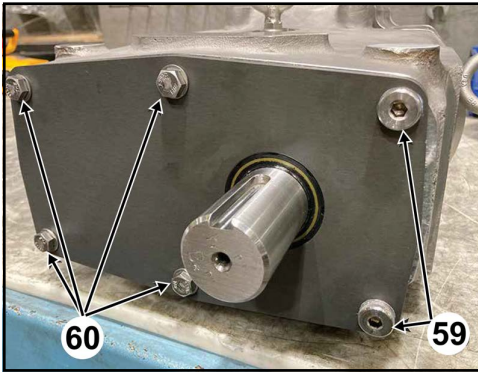

Figure 253 - Remove fasteners

2. Remove the fasteners from the gear case cover; the two socket head shoulder bolts (Figure 253, item 59) from the two holes by the drive shaft, and the four (six on the 220 and 224-UTS) hex head cap screws (item 60) from the remaining holes.

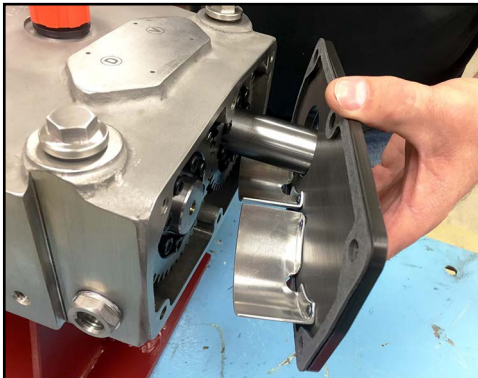

Figure 254 - Remove gear case cover

3. Remove the gear case cover. Discard the cover gasket as shown in Figure 254.

Remove gear from short shaft

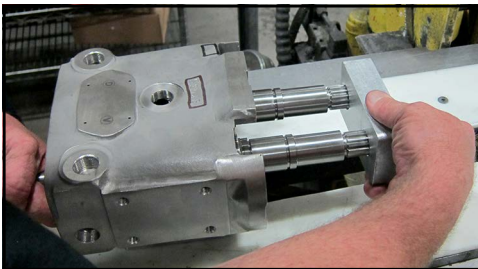

Figure 255 - Block shafts

1. Block the shafts from turning as shown in Figure 255.



Figure 256 - Loosen bolts in locking assembly

2. With an Allen wrench, loosen the screws in the locking assembly by quarter turns, until you can see a few threads as shown in Figure 256.

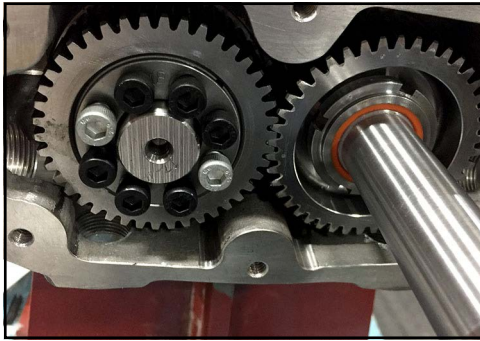

Figure 257 - Locking assembly

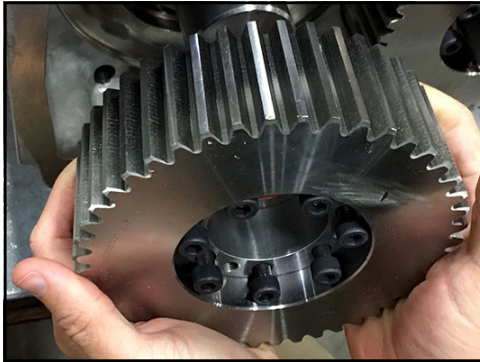

Figure 258 - Remove gear

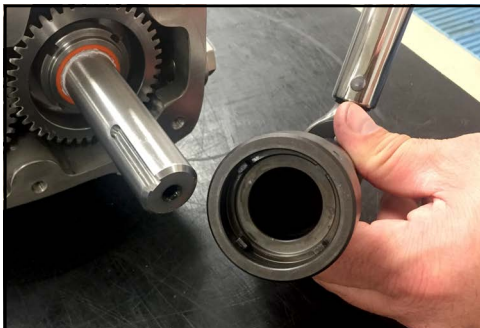

Figure 259 - Gear nut driver tool



Figure 260 - Loosen locking nut

3. If the locking assembly does not self-release, tap the screws lightly with a mallet (or use thread jacking holes) to loosen the gear as shown in Figure 257.
4. Pull the gear and locking assembly off the shaft and place it on a protected surface as shown in Figure 258.

Remove gear from drive shaft

1. Align the tabs on the socket of the gear nut driver tool (part numbers on page 151) with the indents on the locking nut as shown in Figure 259.
2. Loosen the locking nut as shown in Figure 260.



Figure 261 - Remove locking nut and gear

3. Remove the locking nut as shown in Figure 261.

NOTE: The locking nut is one-time use only; discard it after removal and replace it with a new locking nut when reassembling.

Remove shaft

1. Loosen and remove the rear bearing retainer bolts (1) as shown in Figure 262.

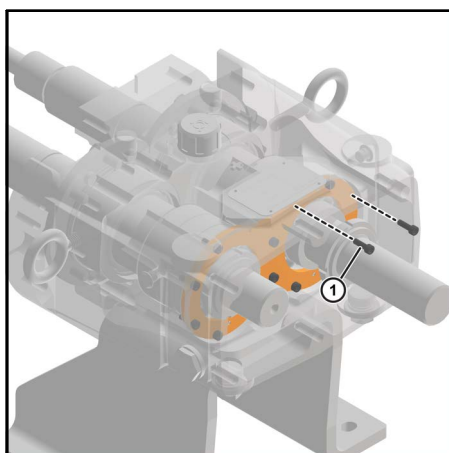

Figure 262 - Loosen and remove rear bearing retainer bolts

2. Remove the rear bearing retainer (1) as shown in Figure 263.

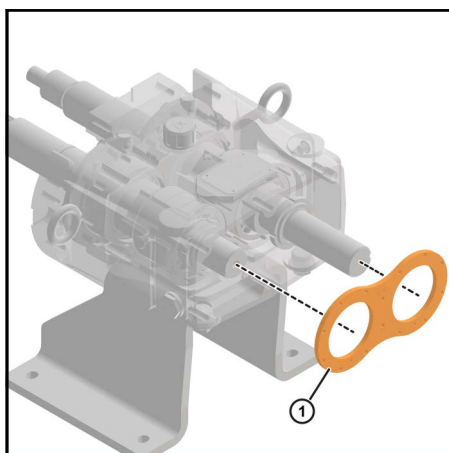

Figure 263 - Remove rear bearing retainer

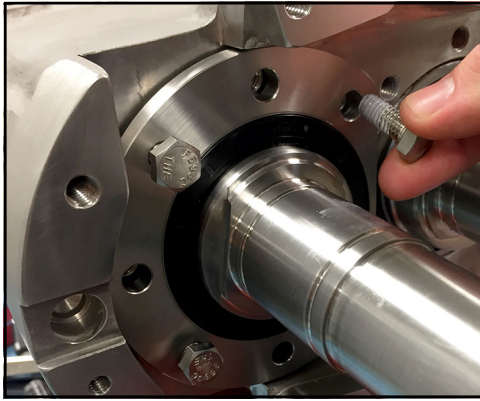

Figure 264 - Loosen and remove bearing retainer bolts

3. Loosen and remove the bearing retainer bolts as shown in Figure 264.

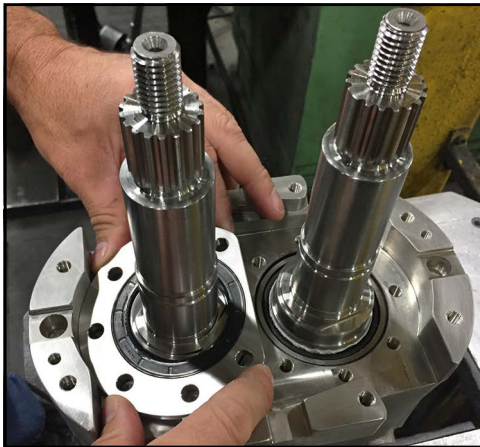

Figure 265 - Remove bearing retainer

4. Remove the bearing retainers as shown in Figure 265.

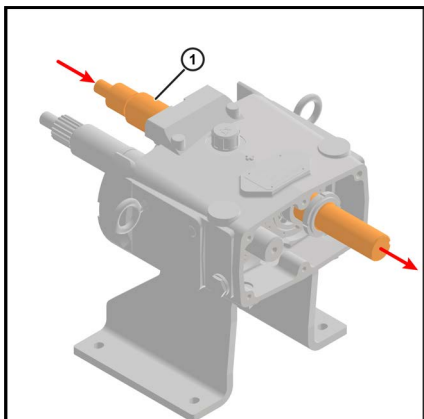

Figure 266 - Tap drive shaft out of gear case

5. Grasp the shaft (1) with one hand and tap it out of the gear case with a rubber mallet as shown in Figure 266.

NOTE: A hydraulic press may be required to remove the shafts.

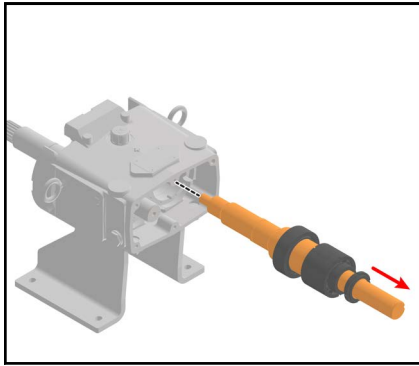

Figure 267 - Pull drive shaft out of gear case

- Pull the drive shaft out of the gear case as shown in Figure 267

NOTE: Repeat steps 3 and 4 for the short shaft removal.

Shaft disassembly

- Before pressing, remove the outer race of the needle roller bearing.
- Use a hydraulic press and V-blocks (Figure 268, item A) to remove the bearings (Figure 268, items 1 and 2) and gear spacer (on drive shaft only, not shown).

NOTE: Make sure both ends of the shaft are protected when removing the shaft.

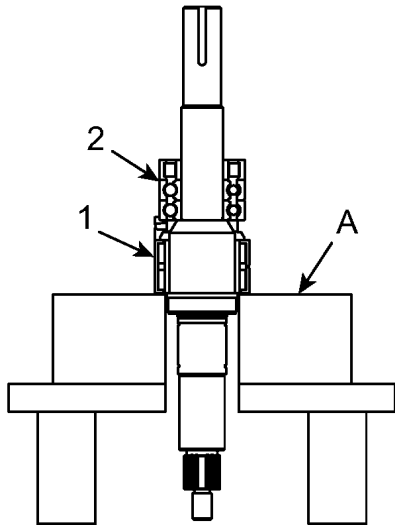

Figure 268 - Press bearings off shaft

Gear Case Assembly Of UTS PLUS

⚠ DANGER

To avoid serious injury, DO NOT install, clean, service, or repair the pump unless all power is off and locked out, and the pump is de-pressurized.

⚠ DANGER

To avoid serious injury, shut off and drain product from the pump prior to disconnecting piping.

NOTE: This section applies for UTS PLUS version Gear Cases ONLY.

UTS PLUS Gear Cases have unique parts & maintenance instructions. Specific Parts are not to be interchanged between Gear Case versions.

Follow Installation/Disassembly Instructions Carefully for UTS PLUS Version.

NOTE: Identify & Verify Gear Case Version.

NOTE: UTS PLUS is available in 030 & 130 sizes only.

UTS PLUS Gear Cases have cast-in 'PLUS' symbol at top as shown in Figure 251.



Figure 269 - - PLUS' symbol

Shaft assembly components

L-R in Figure 270:

Top row: Drive shaft, drive shaft spur gear

Bottom row: Needle roller bearing*

Four point angular contact bearing

Cylindrical roller bearing

Four point angular contact bearing

Gear spacer

Gear key

Locking nut

L-R in Figure 271:

Top row: Short shaft, short shaft spur gear

Bottom row: Needle roller bearing*

Four point angular contact bearing

Cylindrical roller bearing

Four point angular contact bearing

Locking nut

Locking assembly

*030-UTS PLUS has a single needle roller bearing

Shaft assembly



Figure 270 - Drive Shaft: Assembly items needed



Figure 271 - Short Shaft: Assembly items needed

NOTE: 030-UTS PLUS and 130-UTS PLUS: Check the shafts to make sure they have a "+" inscribed on them; that indicates it is a UTS PLUS component. Standard 030-UTS and 130-UTS shafts and 030-UTS PLUS and 130-UTS PLUS shafts are not interchangeable.



Figure 272 - Apply anti-seize

1. Apply a light coat of anti-seize to the circumference of the shaft as shown in Figure 272.

⚠ CAUTION

To lift the shafts on the 130-UTS, please have your maintenance department seek advice for safe lifting practices for objects weighing in excess of 40 lb (18 kg).

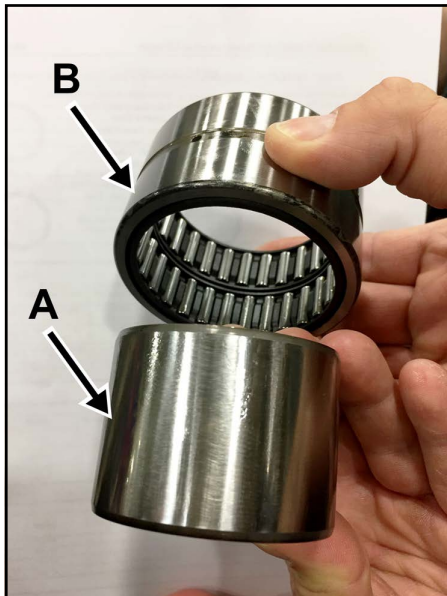

Figure 273 -Remove outer race of needle roller bearing

2. Remove the outer race (Figure 273, item B) of the needle roller bearing. (The inner race is Figure 273, item A).

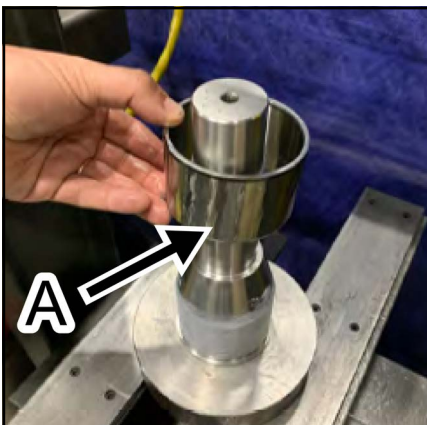

Figure 274 -Place inner race on shaft

3. Place the inner race of the needle roller bearing (Figure 274, item A) onto the shaft.

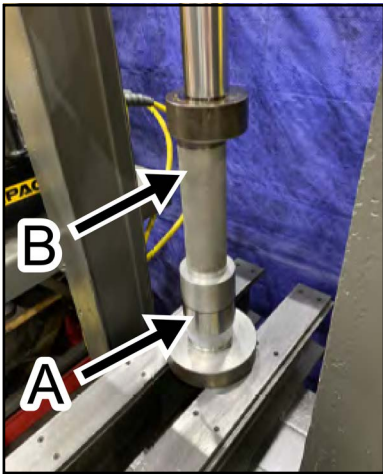

Figure 275 -Place race onto shaft



Figure 276 -Inner race installed on shaft

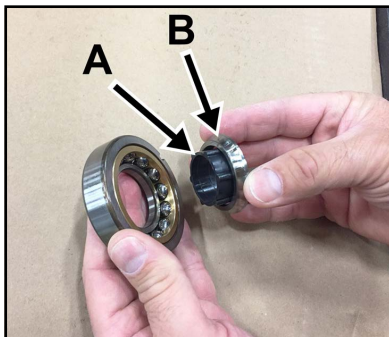

Figure 277 -Remove insert and race

4. Press the inner race of the needle roller bearing (Figure 275, item A) onto the shaft as shown. Figure 275, item B is a bearing press assembly tool.

NOTE: The outer race of the needle roller bearing is installed later on page 77.

5. Press the inner race of the needle roller bearing onto the shaft until it seats against the lip of the shaft as shown in Figure 276.

6. Remove the plastic insert (Figure 277, item A) and race (Figure 277, item B) from one of the two four point angular contact bearings.

NOTE: There are two four point angular contact bearings per shaft, and two races per bearing. The races are installed on the shaft individually, so for ease of identification during assembly, keep the races paired with the bearings. When you remove the races, face them toward the side of the bearing from which they have been removed.



Figure 278 -Remove bottom race



Figure 279 -Apply anti-seize to shaft



Figure 280 -Place race onto shaft



Figure 281 -Press race onto shaft

7. Remove the race from the other side of the four point angular contact bearing Figure 278.

NOTE: here are two four point angular contact bearings, so make sure the races remain in position in relation to each bearing. The smaller side of each race always faces in toward the ball bearings; the larger flanged side of each race always faces out.

8. Apply a light coat of anti-seize to the shaft as shown in Figure 279.

9. Place one race from the four point angular contact bearing onto the shaft. Note the position of the race. Make sure the flange faces down toward the shaft as shown in Figure 280.

10. Press the race of the four point angular contact bearing onto the shaft. Make sure it seats against the step on the shaft as shown in Figure 281.



Figure 282 -Race pressed on shaft



Figure 283 -Place bearing onto race



Figure 284 -Place race on shaft

11. Figure 282 shows the race seated against the step on the shaft.

12. With the slot on the bearing facing down, place the four point angular contact bearing onto the race as shown in Figure 283.

NOTE: The slot location does not affect the function.

13. Place the second race of the four point angular contact bearing onto the shaft. Note the position of the race. Make sure the narrower side of the race faces down toward the ball bearings, as shown in figure. Press the race into the bearing as shown in Figure 284.



Figure 285 -Race installed on shaft

14. Figure 285 shows the four point angular contact bearing installed on the shaft.



Figure 286 -Place race onto shaft

15. Place the inner race of the cylindrical roller bearing onto the shaft as shown in Figure 286.



Figure 287 -Press race onto shaft

16. Press the inner race of the cylindrical roller bearing onto the shaft until it contacts the four point angular contact bearing already installed as shown in Figure 287.



Figure 288 -Place bearing onto race

17. Place the outer race of the cylindrical roller bearing onto the inner race installed on the shaft as shown in Figure 288.



Figure 289 -Place race on shaft



Figure 290 -Press race into bearing



Figure 291 -Place bearing onto race

18. Place the race of the next four point angular contact bearing onto the shaft. Note the position of the race. Make sure the flanged side of the race faces down toward the shaft, as shown in Figure 289.

19. Press the race of the next four point angular contact bearing onto the shaft, until it seats against the cylindrical roller bearing installed in step 20.

20. Place the four point angular contact bearing onto the race as shown in Figure 291.

Place bearing onto race.



Figure 292 -Place race on shaft

21. Place the second race of the four point angular contact bearing onto the shaft. Note the position of the race. Make sure the narrower side of the race faces down toward the ball bearings as shown in Figure 292.

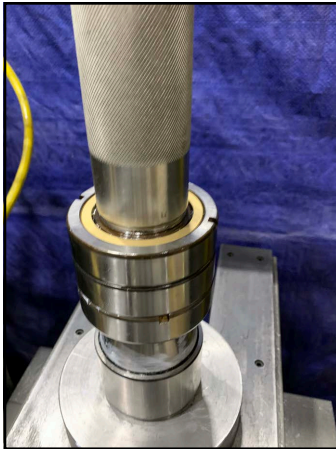

Figure 293 -Press race into bearing

22. Press the race of the four point angular contact bearing onto the shaft, until it seats into the bearing as shown in Figure 293.

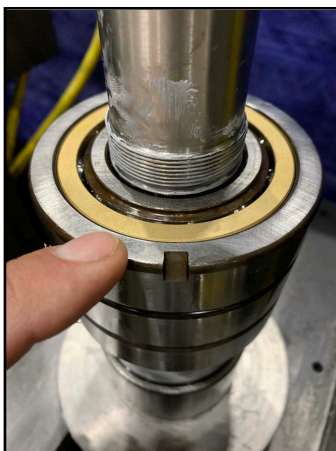

Figure 294 -Second bearing installed

23. Figure 294 shows the second four point angular contact bearing installed.



Figure 295 - -Place locking nut onto shaft



Figure 296 -Press race into bearing



Figure 297 -Place locking nut on to shaft

24. Place the locking nut onto the shaft as shown in Figure 295.

25. For the drive shaft, repeat steps 1 through 23, then skip to step 25. For the short shaft, continue.

26. Short shaft only: Apply anti-seize to the shaft. Place a new locking nut onto the shaft, and screw it on finger-tight as shown in Figure 297.



Figure 298 -Torque down locking nut

27. Short shaft only: Place the shaft in a holding device clamped into a vise, then torque down the locking nut onto the shaft as shown in Figure 298.

Table 12: Torque Values - Locking Nut	
015-UTS	75 ft-lb (102 N·m)
030-UTS	100 ft-lb (136 N·m)
130-UTS	140 ft-lb (190 N·m)
220-UTS	230 ft-lb (312 N·m)

28. Short shaft only: skip to “Install shafts in gear case” on page 112.

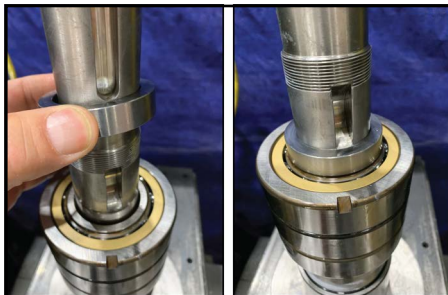

Figure 299 -Place gear spacer on drive shaft

29. Drive shaft only: Place the gear spacer onto the shaft until it contacts the four point angular contact bearing already installed as shown in Figure 299.

NOTE: Make sure the gear spacer is positioned so that the flanged side is up.



Figure 300 -Place key in key way

30. Drive shaft only: Place the key in the key way on the shaft as shown in Figure 300.



Figure 301 -Tap key into key way



Figure 302 -Shaft ready to be installed

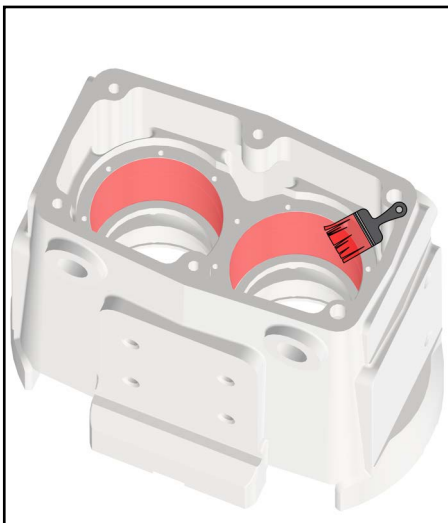

Figure 303 -Apply anti-seize

31. Drive shaft only: Tap the key in with a hammer as shown in Figure 301.

32. Shaft is ready to install in to the gearcase as shown in Figure 302.

Install shafts in gear case

1. Place the gear case on an arbor press. Apply anti-seize to the lip of the shaft bores as shown in Figure 303.

⚠ CAUTION

To lift the gear case assembly on the 130-UTS, attach lifting straps/chains to the two eye bolts on either side of the gear case.

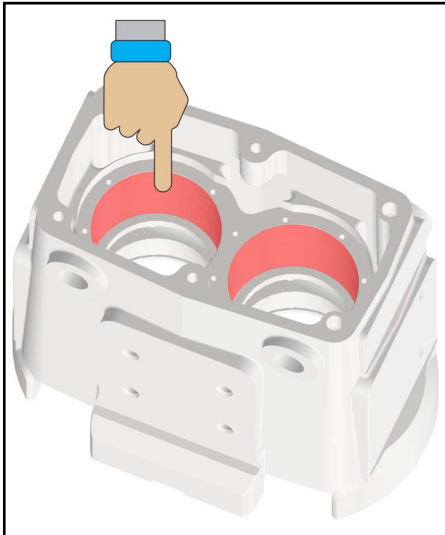

Figure 304 -Spread even layer



Figure 305 -Place drive shaft in bore

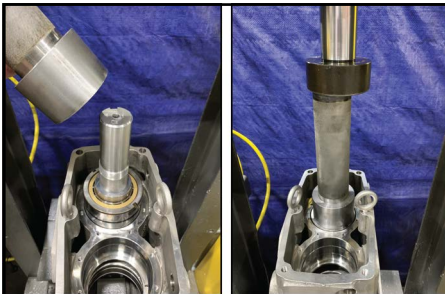

Figure 306 - Press the drive shaft

2. Rub a finger around the bore to spread the anti-seize in a thin, even layer around the inner lip of the bore as shown in Figure 304.

3. Place the gear case front face down to have the back end of the gearcase facing up. From behind the gearcase, the drive shaft is located on the right side. Insert the drive shaft into the gear case as shown in Figure 305.

NOTE: The UTS pump can only be mounted in one direction, so the shafts must be installed in the respective shaft bores as shown in Figure 305 and Figure 306.

4. Press the drive shaft into the gearcase seating the bearing into the gearcase as shown in Figure 306.

NOTE: The inner race of the needle roller bearing was pressed onto the shaft in step 3 on page 103.

⚠ CAUTION

Ensure that the shaft is vertical and in line with the bore before and during pressing operations.

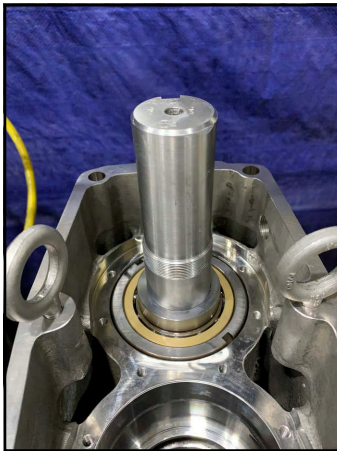

Figure 307 -Place drive shaft in bore

5. Bearing shown fully seated in the gearcase as shown in Figure 307.

Repeat this procedure for the second shaft.

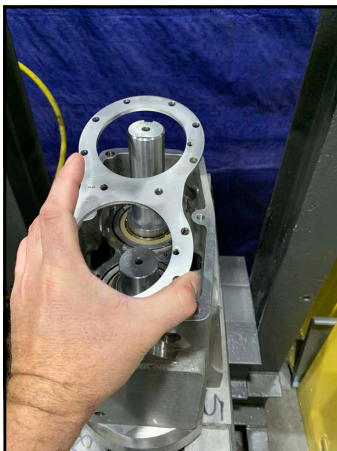

Figure 308 -Installing the rear bearing retainer plate.

6. Install the rear bearing retainer plate as shown in Figure 308.



Figure 309 -Rear bearing retainer plate

7. Rear bearing retainer plate shown in proper position as shown in Figure 309.



Figure 310 -Applying loctite Blue 242 to the rear bearing retainer bolts.

- Apply loctite to the rear bearing retainer bolts as shown in Figure 310.

NOTE: Loctite Blue 242, medium-strength thread locker, or approved equivalent

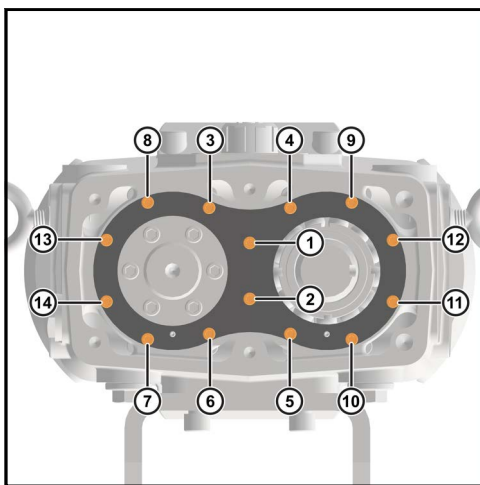

Figure 311 -Install and torque the rear bearing retainer bolts

- Install and torque the rear bearing retainer bolts to the stated specification as shown in Figure 311.

NOTE: Hand tighten all screws to contact plate to gearcase as per sequence.

Table 13: Torque Values - Rear Bearing Retainer Bolt			
Pump Model	Half Torque	Full Torque	Torque Sequence
030-UTS PLUS	10 in-lb (0.85 ft-lb) 1.13 N·m	20 in-lb (1.5 ft-lb) 2.25 N·m	1-14
130-UTS PLUS	40 in-lb (3.5 ft-lb) 4.6 N·m	75 in-lb (6 ft-lb) 8.5 N·m	1-14



Figure 312 -The rear bearing retainer bolts

- Figure 312 shows the rear bearing retainer bolts installed.



Figure 313 -Place outer race on the shafts

11. Place the outer race of the needle roller bearings on the drive and short shafts as shown in Figure 313.

NOTE: The inner race of the needle roller bearing was pressed onto the shaft in step 3 on page 103.



Figure 314 -Press the bearing races into the gear case

12. Align the oil hole in each outer bearing race with the bottom of the pump. Then press the bearing races into the gear case until seated as shown in Figure 314.

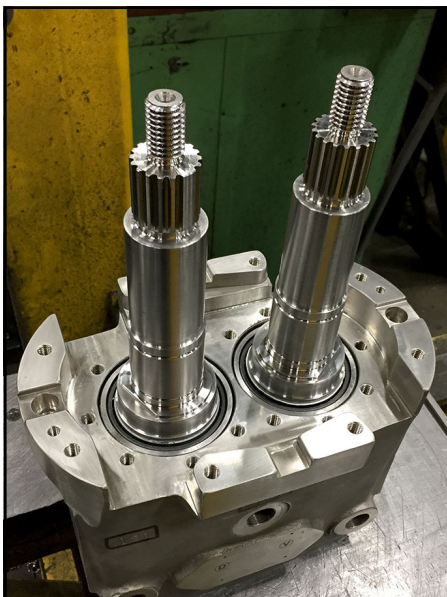

Figure 315 -Bearing outer races seated into gear case

13. Shown with bearing outer races fully seated into the gear case as shown in Figure 315

NOTE: REFER TO BEARING RETAINER INSTALLATION ON PAGES: 82 - 95.

Reference Tables

Pump Model	Oil Capacity	Oil	Change oil
015-UTS	110 ml	Standard: Synthetic Mobil SHC 629-150, part no. 139215+ Food Grade: Synthetic Mobil SHC Cibus-150, part no. 139684+	250 hours, every 2000 hours thereafter*
030-UTS	216 ml		
130-UTS	525 ml		
220-UTS	1575 ml		

* Aggressive washdown or extreme running conditions may require more frequent intervals.



For more information, see "Lubrication" on page 28.

Pump Model	Torque Values		Wrench Size	
	Screw Nut	Cover Nut	Screw Nut	Cover Nut
015-UTS	30 ft-lb (41 N·m)	7 ft-lb (10 N·m)	15/16"	5/8"
030-UTS	55 ft-lb (68 N·m)	11 ft-lb (15 N·m)	1-1/4"	
130-UTS	120 ft-lb (163 N·m)	25 ft-lb (34 N·m)	1-5/8"	7/8"
220-UTS	275 ft-lb (373 N·m)	55 ft-lb (75 N·m)	2-1/4"	

Torque Values - Gear Case				
Pump Model	Front Bearing Retainer Bolts	Locking Nut	Gear Case Cover Fasteners	
			HHCS	SHSB
015-UTS	24 in-lb / 2 ft-lb (3 N·m)	75 ft-lb (102 N·m)	88 in-lb (10 N·m)	110 in-lb (12 N·m)
030-UTS	84 in-lb / 7 ft-lb (9 N·m)	100 ft-lb (136 N·m)	110 in-lb (12 N·m)	132 in-lb (15 N·m)
130-UTS	180 in-lb / 15 ft-lb (20 N·m)	140 ft-lb (190 N·m)	132 in-lb (15 N·m)	176 in-lb (20 N·m)
220-UTS	300 in-lb / 25 ft-lb (34 N·m)	230 ft-lb (312 N·m)		

Torque Values - Gear Case						
Pump Model	Rear Bearing Retainer Bolts Half Torque	Rear Bearing Retainer Bolts Full Torque	Torque Sequence	Locking Nut	Gear Case Cover Fasteners	
					HHCS	SHSB
030-UTS PLUS	10 in-lb (0.85 ft-lb) 1.13 N·m	20 in-lb (1.5 ft-lb) 2.25 N·m	1-14	100 ft-lb 136 N·m	110 in-lb 12 N·m	132 in-lb 15 N·m
130-UTS PLUS	40 in-lb (3.5 ft-lb) 4.6 N·m	75 in-lb (6 ft-lb) 8.5 N·m	1-14	140 ft-lb 190 N·m	132 in-lb 15 N·m	176 in-lb 20 N·m

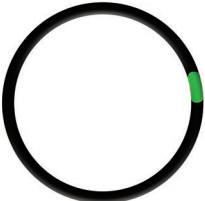
Torque Values - Locking Assembly				
Pump Model	Screw Hex Size	Qty.	Half Torque	Full Torque
015-UTS	5 mm	8	63 in-lb (7 N·m)	126 in-lb (14 N·m)
030-UTS	5 mm	6	79 in-lb (9 N·m)	158 in-lb (18 N·m)
130-UTS, 220-UTS	6 mm	6	189 in-lb (21 N·m)	378 in-lb (43 N·m)

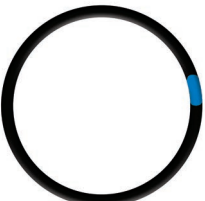
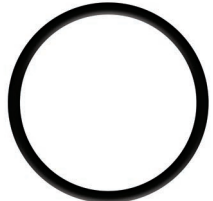
Standard O-Ring Selections, Descriptions and Color Codes for UTS Pumps			
<p>Ethylene Propylene Diene Rubber (EPDM) Compound Color: Black or Purple Color Code: Green FDA Compliant to 21CFR177.2600</p>		<p>Fluorocarbon Rubber (FKM) Compound Color: Rust, Brown or Black Color Code: White FDA Compliant to 21CFR177.2600 3-A Sanitary</p>	
<p>Ethylene Propylene Diene Rubber (Sulfur Free) (EPDM) Compound Color: Black or Purple Color Code: Blue FDA Compliant to 21CFR177.2600</p>		<p>Perfluoroelastomer (FFKM) Compound Color: Black Color Code: None Individually packaged with size and material noted.</p>	

Troubleshooting

PROBLEM	POSSIBLE CAUSE	SUGGESTED ACTION
No flow, pump screws are not turning	Drive motor not running.	Check resets, fuses, circuit breakers.
	Keys sheared or missing.	Replace.
	Drive belts, power transmission components slipping or broken.	Replace or adjust.
	Pump shaft, keys, or gears sheared.	Inspect: and replace parts as necessary.
	Screws not properly timed	Check clearances between screw flanks. Re-time if necessary.
No flow, pump screws are turning	Screws turn in the wrong direction.	Check motor hookup to reverse motor rotation.
	Relief valve not properly adjusted, or held open by foreign material.	Adjust or clear valve.
	Suction port is blocked, not allowing flow to the pump.	Check all inlet valves, strainers, tank outlet ports.
	Slip too high	Check flow-speed curve and adjust as necessary.
No flow, pump not priming	Valve closed in inlet line.	Open valve.
	Inlet line clogged or restricted.	Clear line, clean filters, etc.
	Air leaks due to bad gaskets or pipe connections.	Replace gaskets; check lines for leakage (can be done by air pressure or by filling with liquid and pressurizing with air).
	Pump speed too slow.	Increase pump speed.
	Pump speed too fast for high-viscosity liquid.	Decrease pump speed.
	Liquid drains or siphons from system during off periods.	Use foot valve or check valves. Filling inlet lines with material before startup may solve startup priming problems due to no material in system.
	“Air” lock caused by fluids which “gas off,” or vaporize, or allow gas to come out of solution during off periods.	Install and use a manual or automatic air bleed from pump or lines near pump.
	Worn screws	Increase pump speed, use foot valve or check valve to improve priming. Make sure inlet and discharge are not restricted. Replace worn screws.



PROBLEM	POSSIBLE CAUSE	SUGGESTED ACTION
No flow, pump not priming, cont'd	Net inlet pressure available too low.	Check Net Inlet Pressure Available & Net Inlet Pressure Required. Change inlet system as needed.
	On "Vacuum" inlet system: On initial start-up, atmospheric "blow back" prevents pump from developing enough differential pressure to start flow.	Install check valve in discharge line.
	Motor incorrectly sized for the application	Contact SPX FLOW Application Engineering
Insufficient flow	Speed too low or too high to obtain desired flow.	Check flow-speed curve and adjust as necessary.
	Net inlet pressure available too low.	Check Net Inlet Pressure Available & Net Inlet Pressure Required. Change inlet system as needed.
	Air leak due to bad seals, pipe connections, or other equipment.	Replace seals, check inlet fittings.
Insufficient flow—flow being bypassed somewhere	Flow diverted in branch line, open valve, etc.	Check system and controls
	Relief valve not adjusted or jammed.	Clear or adjust valve.
Insufficient flow—high slip	Worn pump.	Increase pump speed (within limits). Replace screws, have pump remanufactured.
	High pressure.	Reduce pressure by adjusting system settings or hardware.
Fluid vaporization ("starved" pump inlet)	Strainers, foot valves, inlet fittings or lines clogged.	Clear lines. If problem continues, inlet system may require changing.
	Inlet line size too small, inlet line too long. Too many fittings or valves. Foot valve, strainers too small.	Increase inlet line size. Reduce length, minimize direction and size changes, reduce number of fittings.
	NIPA - Net Inlet Pressure Available at Pump is too low.	Raise liquid level in source tank to increase Net Inlet Pressure (NIPA). Increase Net Inlet Pressure Available at Pump by raising or pressurizing source tank.
		Select larger pump size with lower Net Inlet Pressure Required. Select a set of screws with a narrower pitch to lower the Net Inlet Pressure Required (NIPR)



PROBLEM	POSSIBLE CAUSE	SUGGESTED ACTION
Fluid vaporization ("starved" pump inlet), cont'd	Fluid viscosity greater than expected.	Reduce pump speed and accept lower flow, or change system to reduce line losses. Change temperature of product to reduce viscosity.
	Fluid temperature higher than expected (vapor pressure higher).	Reduce temperature, reduce speed and accept lower flow or change system to increase Net Inlet Pressure Available.
Noisy operation	Cavitation	
	High fluid viscosity. High vapor pressure fluid. High temperature.	Slow down pump, reduce temperature, change system setup.
	Net Inlet Pressure Available less than Net Inlet Pressure Required.	Increase NIPA - Net Inlet Pressure Required or reduce NIPR - Net Inlet Pressure Required. Contact SPX FLOW if necessary.
	Air or gas in fluid	
	Leaks in the pump or piping. Dissolved gas or naturally aerated products.	Correct leaks. Minimize discharge pressure (also see "Cavitation," above).
Noisy operation caused by mechanical problems	Screw to body contact	
	Improper assembly of pump.	Check clearances
	Distortion of pump due to improper piping installation.	Change piping installation to eliminate piping stress and distortion on body.
	Pressures required higher than the pump is rated for.	Reduce discharge pressure required.
	Worn bearings.	Rebuild with new bearings and lubricate regularly.
	Screw to Screw Contact	
	Loose or incorrectly-timed gears.	This has caused severe damage to components - rebuild with new parts.
	Sheared keys.	This has caused severe damage to components - rebuild with new parts.
Worn gear splines.	This has caused severe damage to components - rebuild with new parts.	
Drive noise caused by gear trains, chains, couplings, bearings.	Repair or replace drive parts. Check bearings for damage and replace as necessary.	



PROBLEM	POSSIBLE CAUSE	SUGGESTED ACTION
Pump requires excessive power (overheats, stalls, high current draw, breakers trip)	Higher than expected viscosity losses.	If within pump rating, increase drive size.
	Higher than expected pressures.	Reduce pump speed. Increase line sizes.
	Fluid is colder with a higher viscosity than expected.	Heat fluid, insulate lines or heat trace lines. Increase line sizes.
Pump requires excessive power, cont'd	Fluid sets in line and pump during shutdown.	Insulate lines or heat trace lines. Install a "soft start" drive. Install a recirculating bypass system. Flush system with a nonsetting fluid.
	Fluid builds up on pump surfaces.	Replace the pump with more running clearances.
Short pump service life	Pumping abrasives	Larger pumps at slower speeds.
	Speeds and pressures higher than rated.	Reduce speeds and pressures by making changes in the system. Replace pump with a larger model with higher pressure ratings.
	Worn bearings and gears due to lack of lubrication.	Check and replace bearing and gears as necessary. Adjust lubrication schedule to decrease time between lubrication. Modify external wash down method to reduce water entering into gear case.
	Misalignment of drive and piping. (Excessive overhung load or misaligned couplings.)	Check alignment of piping and drive. Adjust as necessary.



Pump Dimensions

Universal Twin Screw PD Pump Dimensions

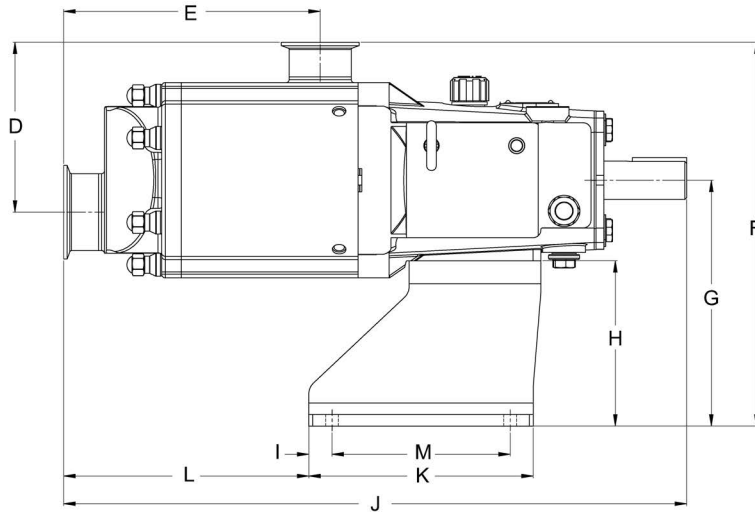
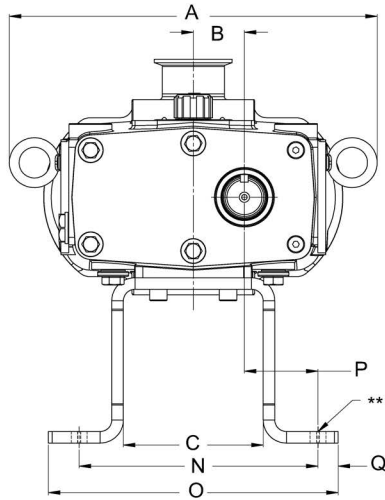

** The bottom pads have slotted bolt holes. The dimensions shown are to the center of the slots.

NOTE: In the table, H=Horizontal port and V=Vertical port.

SIZE		A	B	C	D	E	F	G	H	I	J
015-UTS	in	9.8	1.3	4.3	4.6	6.4	11.8	8.0	5.9	0.8	16.7
	mm	249	33	109	116	163	301	203	149	19	423
030-UTS	in	11.9	1.7	4.5	5.5	8.3	12.5	8.0	5.4	0.8	20.1
	mm	302	42	115	140	210	317	203	137	19	511
130-UTS	in	16.4	2.3	6.9	6.7	10.5	16.6	11.0	7.5	1.0	25.8
	mm	416	57	174	170	267	422	279	191	25	656
220-UTS 4"H x 4"V	in	20.4	3.0	7.4	11.6	15.6	20.3	11.0	6.5	1.0	33.8
	mm	518	76	189	295	396	515	279	165	25	859
220-UTS 4"H x 6"V	in	20.4	3.0	7.4	12.6	15.6	21.3	11.0	6.5	1.0	33.8
	mm	518	76	189	320	396	541	279	165	25	859
220-UTS 6"H x 4"V	in	20.4	3.0	7.4	10.6	16.0	20.3	11.0	6.5	1.0	34.2
	mm	518	76	189	269	406	515	279	165	25	869
220-UTS 6"H x 6"V	in	20.4	3.0	7.4	11.6	16.0	21.3	11.0	6.5	1.0	34.2
	mm	518	76	189	295	406	541	279	165	25	869

SIZE	mm	K	L	M	N **	O	P **	Q
015-UTS	in	7.2	4.5	5.8	7.7	9.4	2.6	0.8
	mm	184	114	146	196	238	65	21
030-UTS	in	7.2	7.9	5.8	7.7	9.4	2.4	0.7
	mm	184	201	146	196	238	60	17
130-UTS	in	7.9	10.5	5.9	10.4	12.1	2.9	0.9
	mm	199	267	149	264	308	75	22
220-UTS 4"H x 4"V	in	8.9	15.7	6.9	11.3	13.3	2.6	1.0
	mm	225	400	175	286	338	67	25
220-UTS 4"H x 6"V	in	8.9	15.7	6.9	11.3	13.3	2.6	1.0
	mm	225	400	175	286	338	67	25
220-UTS 6"H x 4"V	in	8.9	16.1	6.9	11.3	13.3	2.6	1.0
	mm	225	410	175	286	338	67	25
220-UTS 6"H x 6"V	in	8.9	16.1	6.9	11.3	13.3	2.6	1.0
	mm	225	410	175	286	338	67	25

Pump Shaft Guards

⚠ WARNING

Full guards must be installed to isolate operators and maintenance personnel from rotating components.

Guards are provided as part of a complete pump and drive package and are selected by SPX FLOW Engineering for the pump, base, and motor ordered. Do not modify the guard provided by SPX FLOW. If the guard provided by SPX FLOW is lost, contact SPX FLOW Customer Service and provide your order number or PO number of the pump to order a correctly-sized replacement guard.

If the pump was not purchased as a unit, it is the responsibility of the customer to ensure proper guarding. Refer to your local regulations for guidance.

Guard (side view) shown as supplied with an SPX FLOW base package

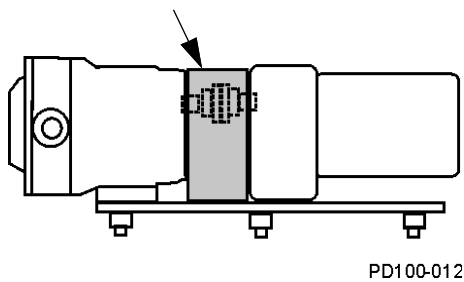

Top view

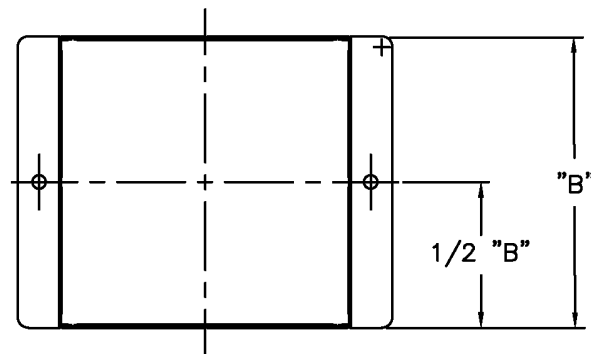

Front view

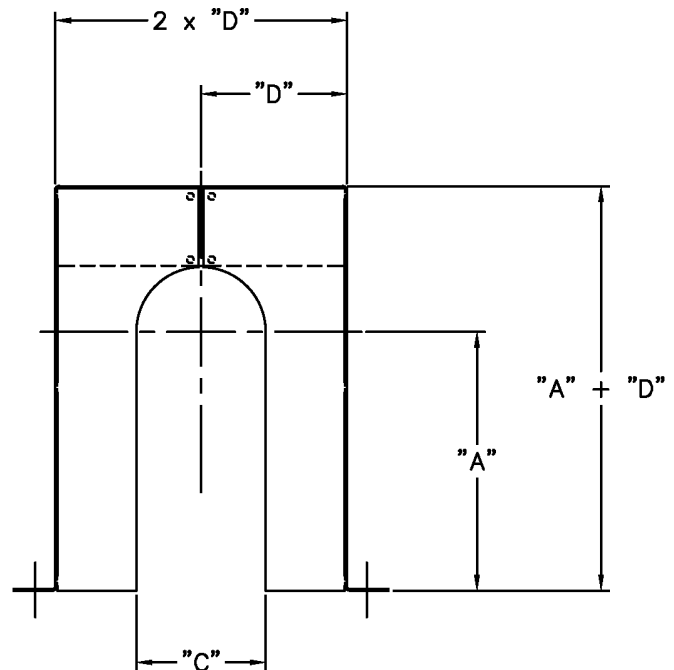

NOTE: Dimensions A, B, C, and D depend on the specific pump unit configuration.

Long Term Storage

Long-term storage (greater than six months) of Waukesha Cherry-Burrell brand pumps:

Before Storage

1. Lubricate all bearings and seals, including:
 - Rubber O-rings and mechanical seal faces (new pump bearings installed from the factory are already lubricated).
 - Motors and drives (see manufacturer's instructions)
2. Be sure the pump contains no water. Make sure to disassemble the wet end and wipe it dry if necessary.
3. Use rust inhibitor on any exposed metal surfaces:
 - Any unpainted surfaces
 - Shafts, nuts/bolts
4. Cover the inlet/outlet connections of the pumps to keep out foreign materials.
5. Put all related instruction manuals in a separate water-tight envelope or container and store them with the equipment.
6. Completely enclose the equipment to prevent contamination from moisture, dust and other possible contaminants. Certain types of plastic wrap materials, when properly used, make excellent storage enclosures.
7. Rotate the pump and drive shafts several turns every 3 months.

Storage

1. Store in a dry location. Indoor storage is preferred. If stored outdoors, the equipment must be in a weather-tight enclosure and shielded from direct sunlight.
2. Maintain even temperatures to prevent condensation.

After Storage

NOTE: Do not start the motor if there is any indication of water contamination. Have the motor checked by a qualified electrician before starting.

1. Remove the equipment from the enclosure and repair or replace any damaged items before using equipment.
2. Check the electric motor (if applicable) per the manufacturer's instructions.
3. Pumps:
 - Completely disassemble the product contact liquid end per the instruction manual.
 - Clean and inspect all parts, including seals and O-rings.
 - Replace rubber parts with any sign of age or damage, such as cracks, taking a set, or loss of elasticity.
4. Lubricate the seal and O-rings and reassemble the liquid end per the instruction manual.
5. Lubricate the motor/drive (if applicable) per the manufacturer's instructions.
6. If the pump has been in storage longer than 1 year, change the oil in the pump and drive.



Parts List

015-UTS Parts

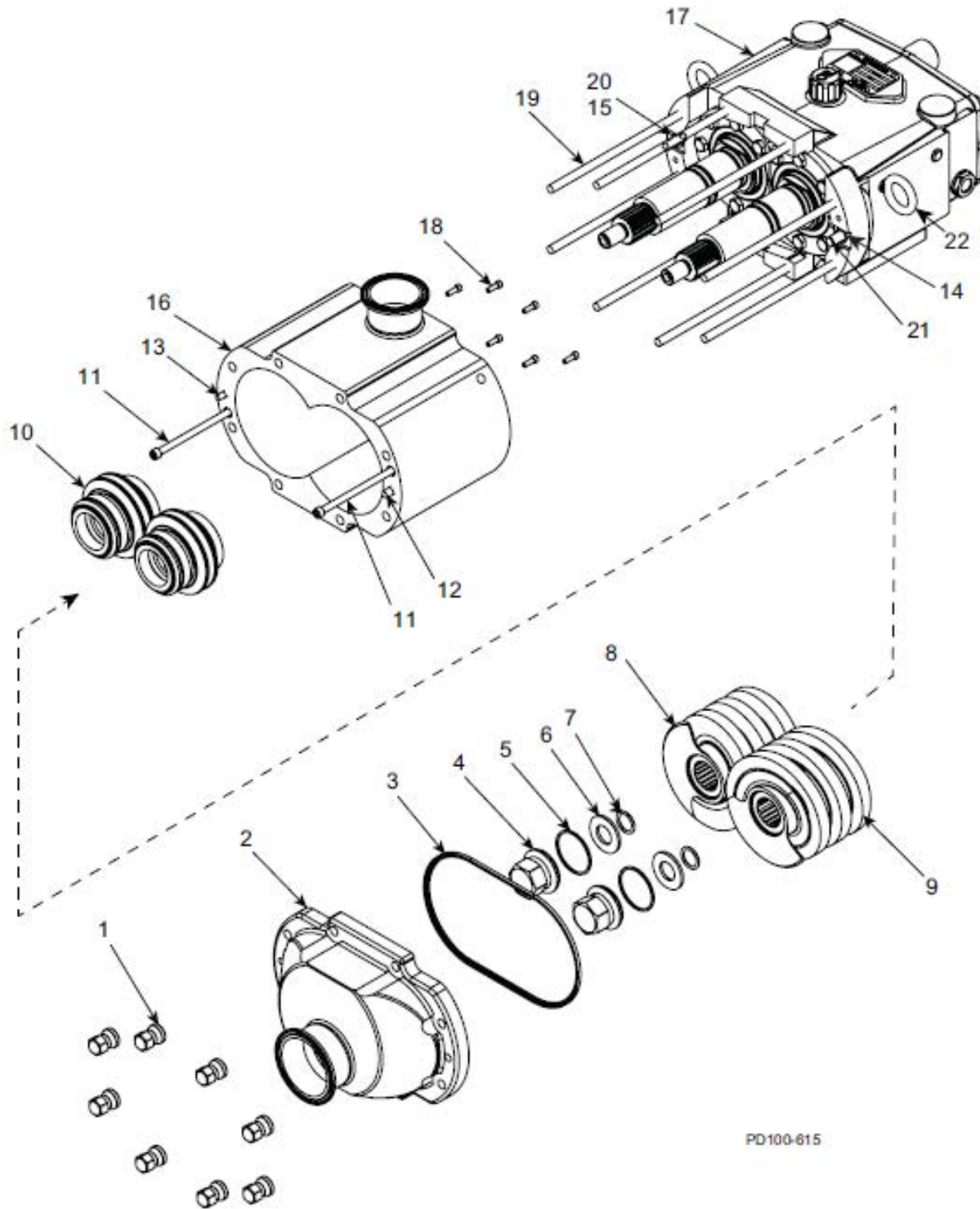

PD100-615

015-UTS Parts

ITEM NO	DESCRIPTION	QTY PER PUMP	PART NO.	NOTES
1	Nut, Acorn	8	108369+	
2	Cover	1	POA	
*	Gasket, Cover, EPDM	1	137424+	
	Gasket, Cover, FKM		137422+	
	Gasket, Cover, FFKM		137423+	
4	Nut, Screw	2	101804+	
*	Screw Nut O-ring EPDM	2	E70126	
	Screw Nut O-ring FKM		V70126	
	Screw Nut O-ring FFKM		K70126	
6	Washer-Belleville	2	101691+	
*	Washer Retainer O-ring EPDM	2	E70112	
	Washer Retainer O-ring FKM		V70112	
	Washer Retainer O-ring FFKM		K70112	
8	Left Hand Screw 16.5 Pitch	1	137363+	
	Left Hand Screw 33 Pitch		136792+	
	Left Hand Screw 44 Pitch		137365+	
9	Right Hand Screw 16.5 Pitch	1	137362+	
	Right Hand Screw 33 Pitch		136791+	
	Right Hand Screw 44 Pitch		137364+	
10	Mechanical Seal Assembly	2	POA	1
11	Body Retaining Screw	2	137096+	
12	Cover Short Dowel Pin	1	137002+	
13	Cover Short Dowel Pin	1	137001+	
14	Bushing, Dowel Pin	1	AD0116100	
15	Bushing, Dowel Pin	1	AD0116000	
16	Pump Body	1	POA	
17	Gear Case Assy	1	POA	
18	SHCS 6-32 x .375 18-8 SS	6	119627+	
19	Stud, Standard Cover	8	137068+	
20	Gear Case Dowel	1	124581+	
21	Gear Case Dowel	1	124582+	
22	Eye Bolt 5/16-18 X .50"LG 304	2	30-719	

Notes:

* Recommended spare part

1. See "Universal Twin Screw Seal Parts" on page 152.

POA: Contact customer service for part number.



015-UTS Parts, continued

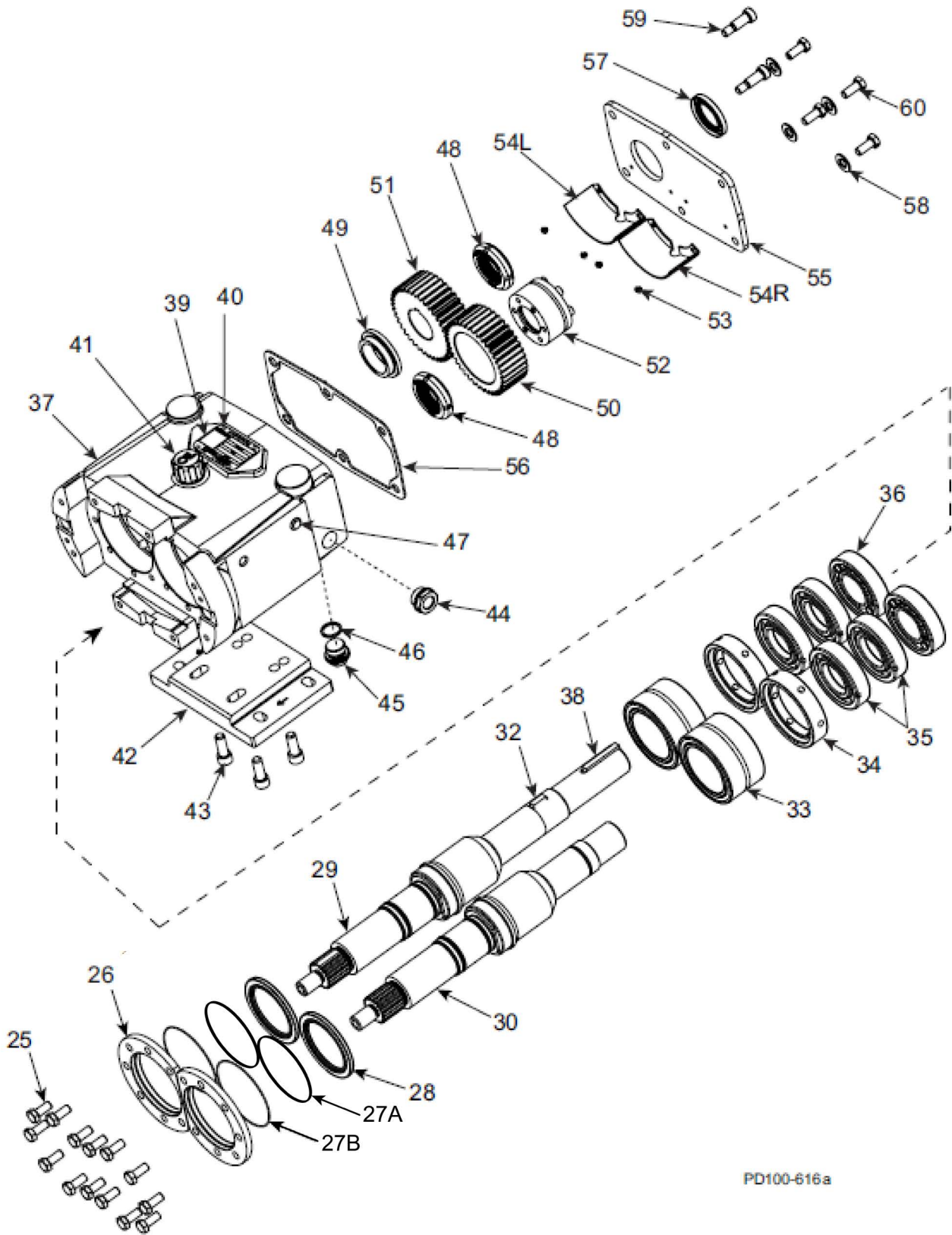

PD100-616a

015-UTS Parts, continued

ITEM NO	DESCRIPTION	QTY PER PUMP	PART NO.	NOTES
25	HHCS 1/4-20 X .75 18-8SS	14	30-58	
26	Bearing Retainer	2	137542+	
27A	Bearing Retainer O-Ring 1	2	304495+	
27B	Bearing Retainer O-Ring 2	2	138856+	
28	Seal, Bearing	2	121679+	
29	Shaft-Drive 17-4 PH	1	136826+	
30	Shaft-Short 17-4 PH	1	136827+	
32	Gear Key	1	015037000+	
33	Needle Roller Bearing	2	137550+	
34	Spacer, Bearing	2	137546+	
35	Four Point Angular Contact Brg.	4	137554+	
36	Cylindrical Roller Brg.	2	137558+	
37	Gear Case - Stainless Stl.	1	136838+	
38	Key .187 x .187 x 1.125	1	000037001+	
39	Nameplate - QR Code	1	135623+	
40	RHDS #2 x .125	4	30-355	
41	Breather Plug-Oil	1	139779+	
42	Gear Case Shim, SS (Mounting Foot)	1	140083+	2
43	SHCS 5/16-18x1.00 SS	4	30-525	
44	Oil Sight Glass - SS	1	137435+	
* 45	Plug-Drain/Level M20x1.5	2	137169+	
46	O-Ring Buna	2	N70114	
47	Plug 5/16" Plastic	2	000121003+	
48	Locking Nut	2	137566+	
49	Spacer-Gear	1	138978+	
50	Gear, Short Shaft, Spur	1	137672+	
51	Gear, Drive Shaft, Spur	1	107997+	
52	Locking Assembly	1	137663+	
53	BHSC Screw 6-32UNC .188 18-8 SS	4	139887+	
54L	Shroud, Gear, 015UTS-LH	1	139155+	
54R	Shroud, Gear, 015UTS-RH	1	139146+	
55	Cover, Gear Case	1	139135+	
56	Gasket, Gear Case/Cover	1	138519+	
57	Oil Seal, Gear Case Cover	1	000030016+	
58	Washer Plain 3/8 18-8 Narrow	4	43-27	
59	SHSB 5/16" X .75"LG 18-8	2	30-690	
60	HHCS 1/4-20 X .75 18-8SS	4	30-58	

Notes:

* Recommended Spare Parts

2. Pumps shipped prior to February 2018 used the shorter mounting foot, 102284+.



030-UTS Parts

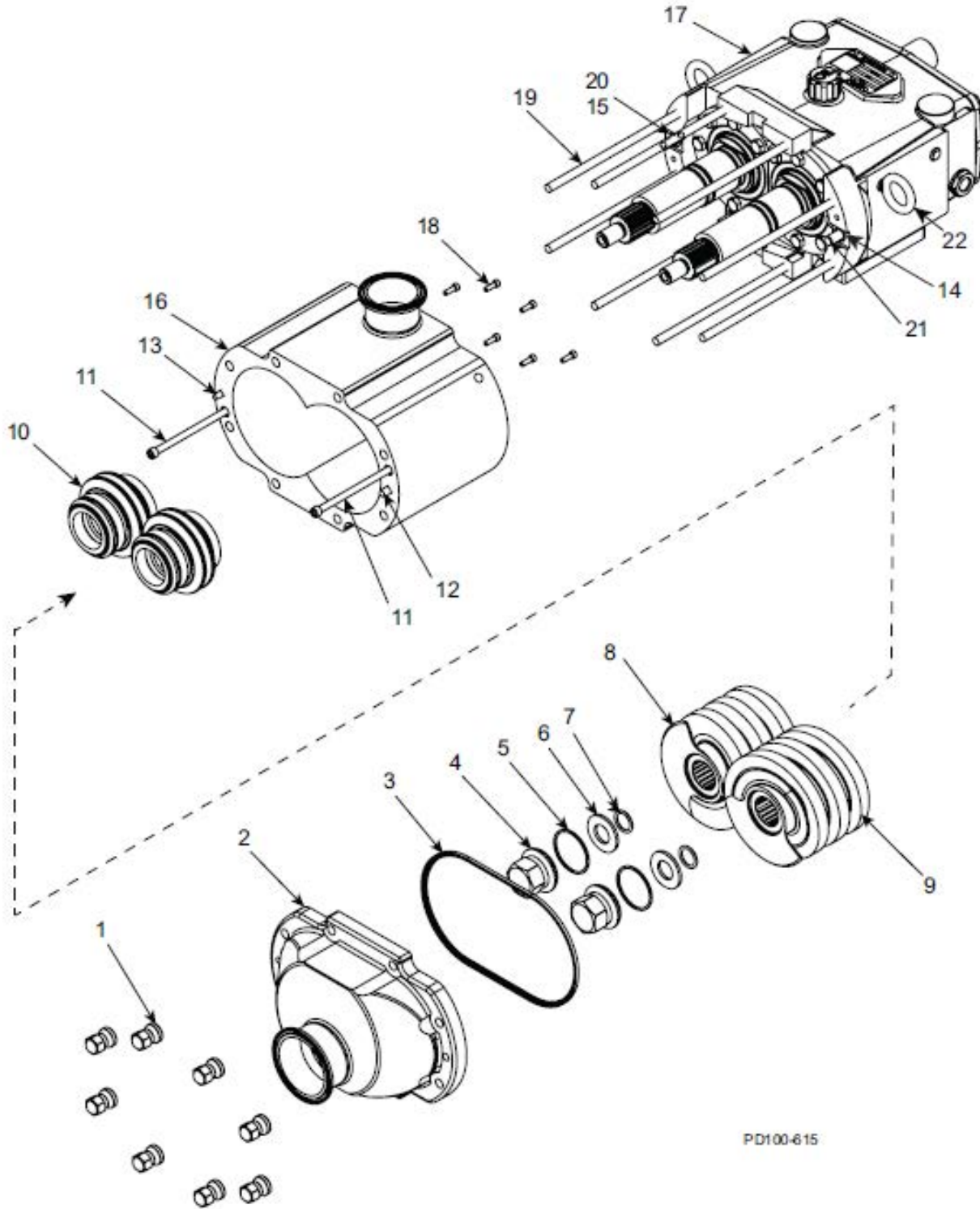

PD100-615

030-UTS Parts

ITEM NO	DESCRIPTION	QTY PER PUMP	PART NO.	NOTES
1	Nut, Acorn	8	108370+	
2	Cover	1	POA	
*	Gasket, Cover, EPDM	1	137427+	
	Gasket, Cover, FKM		137425+	
	Gasket, Cover, FFKM		137426+	
4	Nut, Screw	2	101805+	
*	Screw Nut O-ring EPDM	2	E70130	
	Screw Nut O-ring FKM		V70130	
	Screw Nut O-ring FFKM		K70130	
6	Washer-Belleville	2	101692+	
*	Washer Retainer O-ring EPDM	2	E70115	
	Washer Retainer O-ring FKM		V70115	
	Washer Retainer O-ring FFKM		K70115	
8	Left Hand Screw -16.8 Pitch	1	137367+	
	Left Hand Screw - 28 Pitch		136795+	
	Left Hand Screw - 42 Pitch		137369+	
9	Right Hand Screw - 16.8 Pitch	1	137366+	
	Right Hand Screw - 28 Pitch		136794+	
	Right Hand Screw - 42 Pitch		137368+	
10	Mechanical Seal Assembly	2	POA	1
11	Body Retaining Screw	2	137097+	
12	Cover Short Dowel Pin	1	137002+	
13	Cover Short Dowel Pin	1	137001+	
14	Bushing, Dowel Pin	1	BD0116100	
15	Bushing, Dowel Pin	1	BD0116000	
16	Pump Body	1	POA	
17	Gear Case Assy	1	POA	
18	SHCS 8-32 x .500" 18-8 SS	6	137460+	
19	Stud, Standard Cover	8	137069+	
20	Gear Case Dowel	1	124582+	
21	Gear Case Dowel	1	124583+	
22	Eye Bolt 3/8-16 X .56"LG 304	2	30-720	

Notes:

* Recommended spare part

1. See "Universal Twin Screw Seal Parts" on page 152.

POA: Contact customer service for part number.



030-UTS Parts, continued

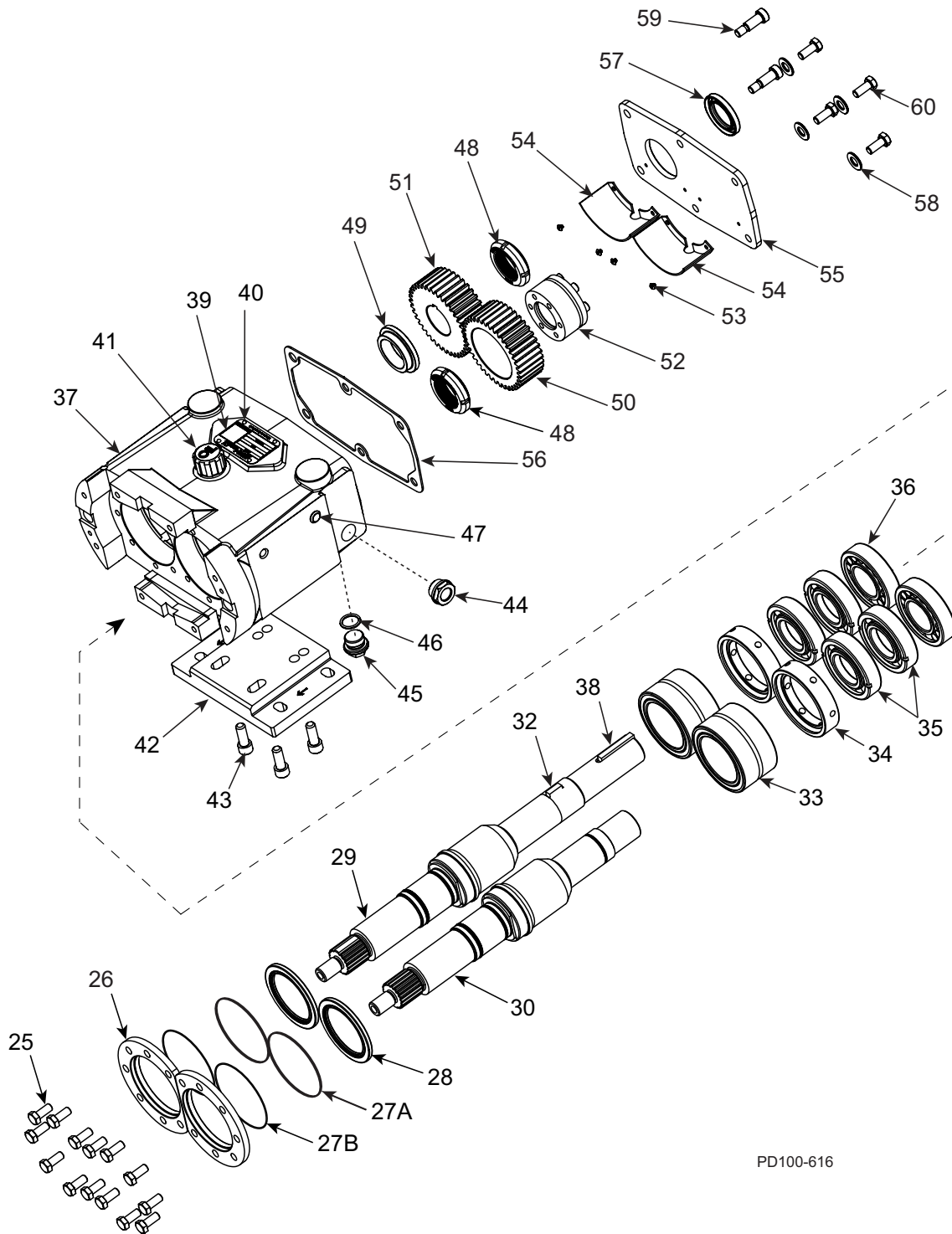

PD100-616

030-UTS Parts, continued

ITEM NO	DESCRIPTION	QTY PER PUMP	PART NO.	NOTES
25	HHCS 5/16-18 X.75" LG 304	14	30-623	
26	Bearing Retainer	2	137543+	
27A	Bearing Retainer O-Ring 1	2	304496+	
27B	Bearing Retainer O-Ring 2	2	138857+	
28	Seal, Bearing	2	121680+	
29	Shaft-Drive 17-4 PH	1	136828+	
30	Shaft-Short 17-4 PH	1	136829+	
32	Gear Key	1	BD0037000	
33	Needle Roller Bearing	2	137551+	
34	Spacer, Bearing	2	137547+	
35	Four Point Angular Contact Brg.	4	137555+	
36	Cylindrical Roller Brg.	2	137559+	
37	Gear Case - Stainless Stl.	1	136840+	
38	Key, .250 x .250 x 1.750	1	000037002+	
39	Nameplate - QR Code	1	135624+	
40	RHDS #2 x .125	4	30-355	
41	Breather Plug-Oil	1	139779+	
42	Gear Case Shim, SS (Mounting Foot)	1	140084+	2
43	SHCS 3/8-16x1.00 18-8 SS	4	30-189	
44	Oil Sight Glass - SS	1	137435+	
45	Plug-Drain/Level M20x1.5	2	137169+	
46	O-Ring Buna	2	N70114	
47	Plug 3/8" Plastic	2	000121002+	
48	Locking Nut	2	137567+	
49	Spacer-Gear	1	138979+	
50	Gear, Short Shaft, Spur	1	108000+	
51	Gear, Drive Shaft, Spur	1	107999+	
52	Locking Assembly	1	108784+	
53	BHSC Screw 6-32UNC .188 18-8 SS	4	139887+	
54	Shroud, Gear	2	139141+	
55	Cover, Gear Case	1	139137+	
56	Gasket, Gear Case/Cover	1	138520+	
57	Oil Seal, Gear Case Cover	1	000030013+	
58	Washer Plain 3/8 18-8 Narrow	4	43-30	
59	SHSB 3/8" X .75" Lg 18-8	2	30-691	
60	HHCS 5/16-18 X.75" LG 304	4	30-623	

Notes:

* Recommended Spare Parts

2. Pumps shipped prior to February 2018 used the shorter mounting foot, 102285+.



130-UTS Parts

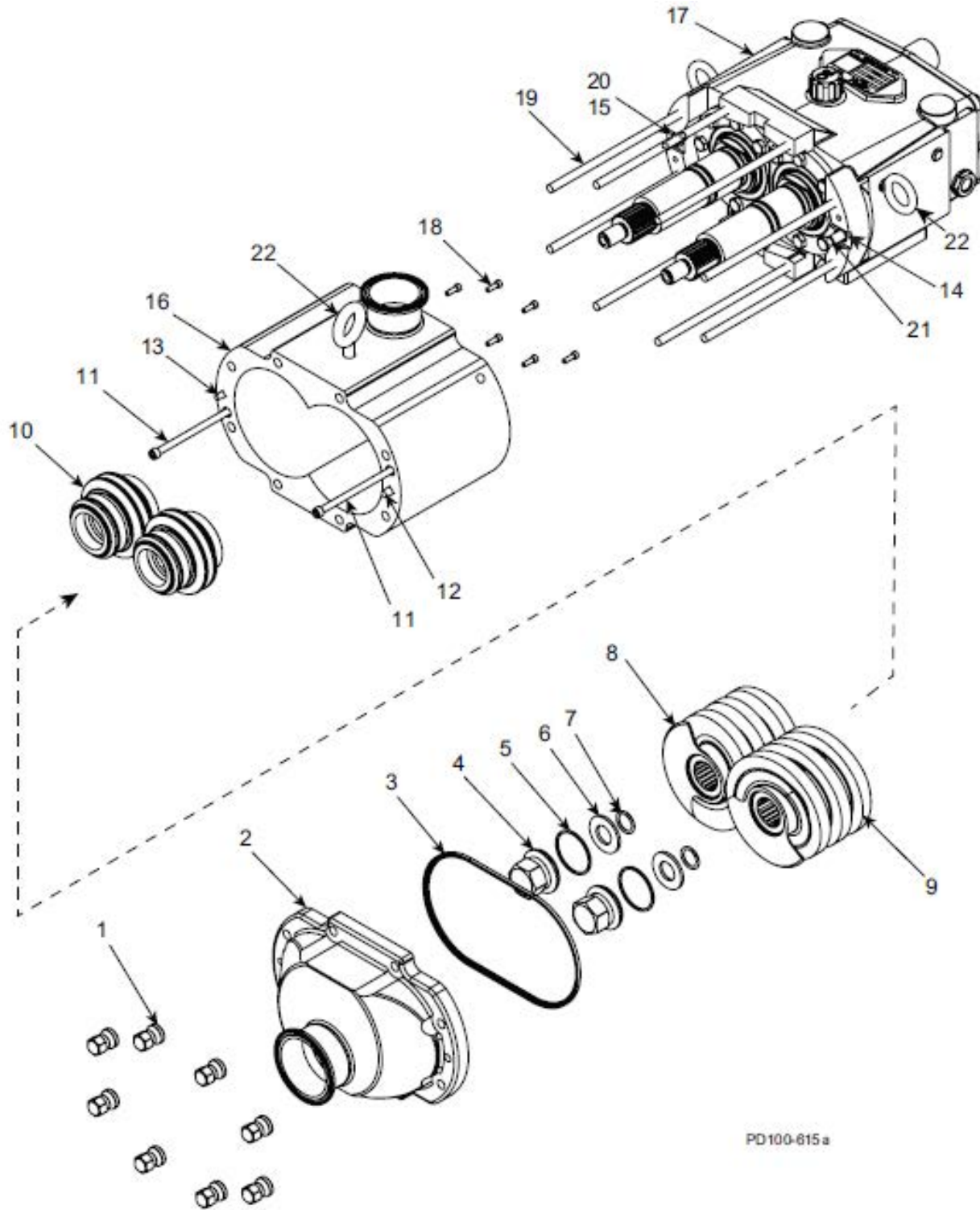

PD100-615a

130-UTS Parts

ITEM NO	DESCRIPTION	QTY PER PUMP	PART NO.	NOTES
1	Nut, Acorn	8	108371+	
2	Cover	1	POA	
*	Gasket, Cover, EPDM	1	137430+	
	Gasket, Cover, FKM		137428+	
	Gasket, Cover, FFKM		137429+	
4	Nut, Screw	2	101806+	
*	Screw Nut O-ring EPDM	2	E70227	
	Screw Nut O-ring FKM		V70227	
	Screw Nut O-ring FFKM		K70227	
6	Washer-Belleville	2	101693+	
*	Washer Retainer O-ring EPDM	2	E70119	
	Washer Retainer O-ring FKM		V70119	
	Washer Retainer O-ring FFKM		K70119	
8	Left Hand Screw - 36.7 Pitch	1	137371+	
	Left Hand Screw - 55 Pitch		136798+	
	Left Hand Screw - 73.4 Pitch		137373+	
9	Right Hand Screw - 36.7 Pitch	1	137370+	
	Right Hand Screw - 55 Pitch		136797+	
	Right Hand Screw - 73.4 Pitch		137372+	
10	Mechanical Seal Assembly	2	POA	1
11	Body Retaining Screw	2	132089+	
12	Cover Short Dowel Pin	1	137003+	
13	Cover Short Dowel Pin	1	137002+	
14	Bushing, Dowel Pin	1	CD0116100	
15	Bushing, Dowel Pin	1	CD0116000	
16	Pump Body	1	POA	
17	Gear Case Assy	1	POA	
18	SHCS 10-32x.50 18-8 SS	6	30-243	
19	Stud, Standard Cover	8	137070+	
20	Gear Case Dowel	1	124584+	
21	Gear Case Dowel	1	124586+	
22	Eye Bolt 1/2-13 X .75"LG 304	3	30-721	

Notes:

* Recommended Spare Parts

2. The shorter mounting foot is 102285+.

POA: Contact customer service for part number.



130-UTS Parts, continued

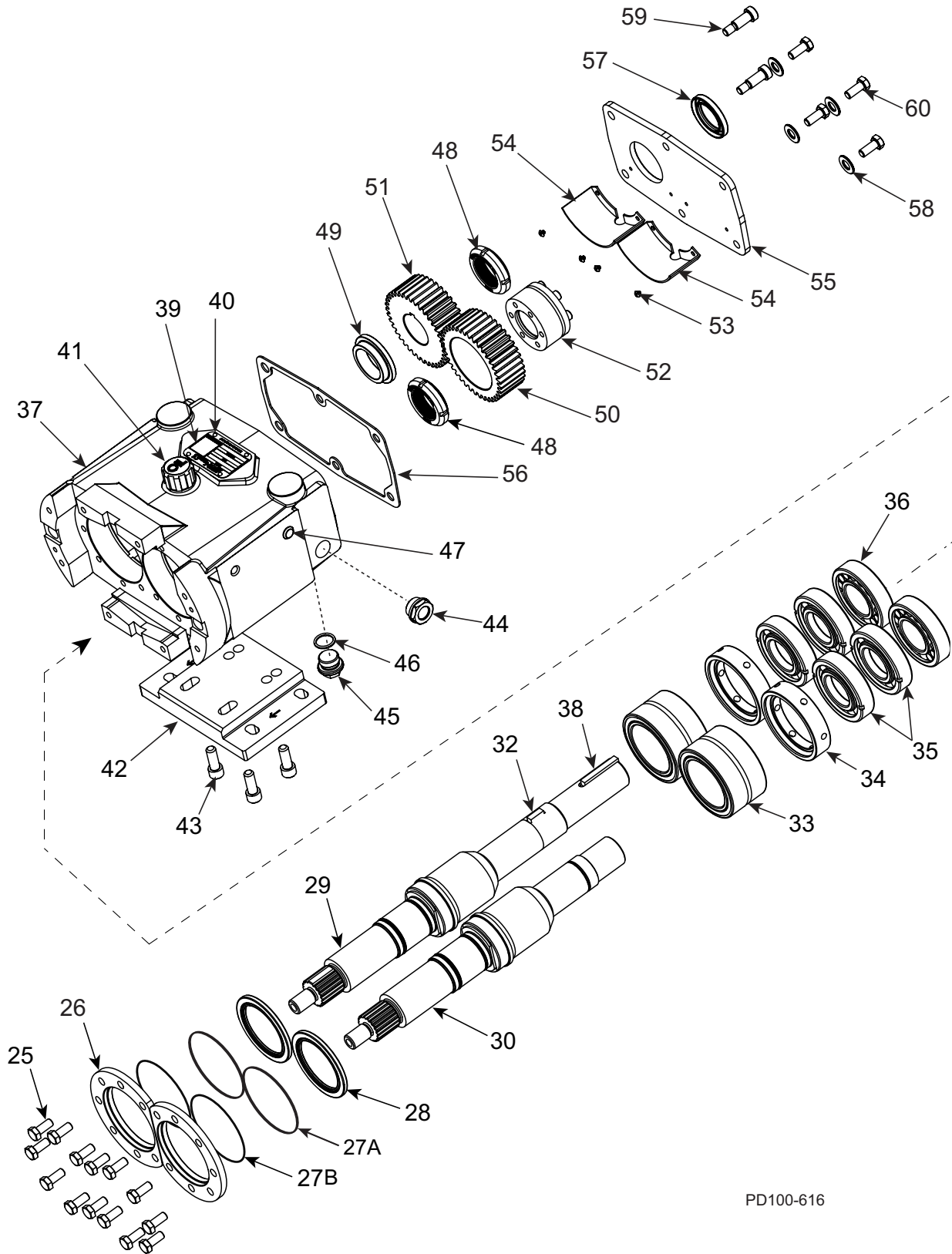

PD100-616

130-UTS Parts, continued

ITEM NO	DESCRIPTION	QTY PER PUMP	PART NO.	NOTES
25	HHCS 3/8-16 X 1.25 18-8 SS	14	30-60	
26	Bearing Retainer	2	137544+	
27A	Bearing Retainer O-Ring 1	2	304497+	
27B	Bearing Retainer O-Ring 2	2	138858+	
28	Seal, Bearing	2	101829+	
29	Shaft-Drive 17-4 PH	1	136830+	
30	Shaft-Short 17-4 PH	1	136831+	
32	Gear Key	1	060037000+	
33	Needle Roller Bearing	2	137552+	
34	Spacer, Bearing	2	137548+	
35	Four Point Angular Contact Brg.	4	137556+x	
36	Cylindrical Roller Brg.	2	137560+	
37	Gear Case - Stainless Stl.	1	136842+	
38	Key 375 x 0.375 x 1.625	1	000037003+	
39	Nameplate - QR Code	1	135624+	
40	RHDS #2 x 0.125	4	30-355	
41	Breather Plug-Oil	1	139779+	
42	Gear Case Shim, SS (Mounting Foot)	1	140085+	2
43	SHCS 1/2-13x1.25"LG 18-8	4	30-503	
44	Oil Sight Glass - SS	1	137435+	
45	Plug-Drain/Level M20x1.5	2	137169+	
46	O-Ring Buna	2	N70114	
47	Plug 1/2" Plastic	2	000121001+	
48	Locking Nut	2	137568+	
49	Spacer-Gear	1	138980+	
50	Gear, Short Shaft, Spur	1	107405+	
51	Gear, Drive Shaft, Spur	1	138508+	
52	Locking Assembly	1	108785+	
53	BHSC Screw 6-32UNC.188 18-8 SS	4	139887+	
54	Shroud, Gear	2	139147+	
55	Cover, Gear Case	1	139139+	
56	Gasket, Gear Case/Cover	1	138521+	
57	Oil Seal, Gear Case Cover	1	000030012+	
58	Washer Plain 3/8 18-8 Narrow	4	43-30	
59	SHSB 1/2" X 1.0" 18-8	2	30-692	
60	HHCS 3/8-16 x 0.75" 18-8	4	30-50	

Notes:

* Recommended spare Parts

2. Pumps shipped prior to February 2018 used the shorter mounting foot, 102286+.



220-UTS Parts

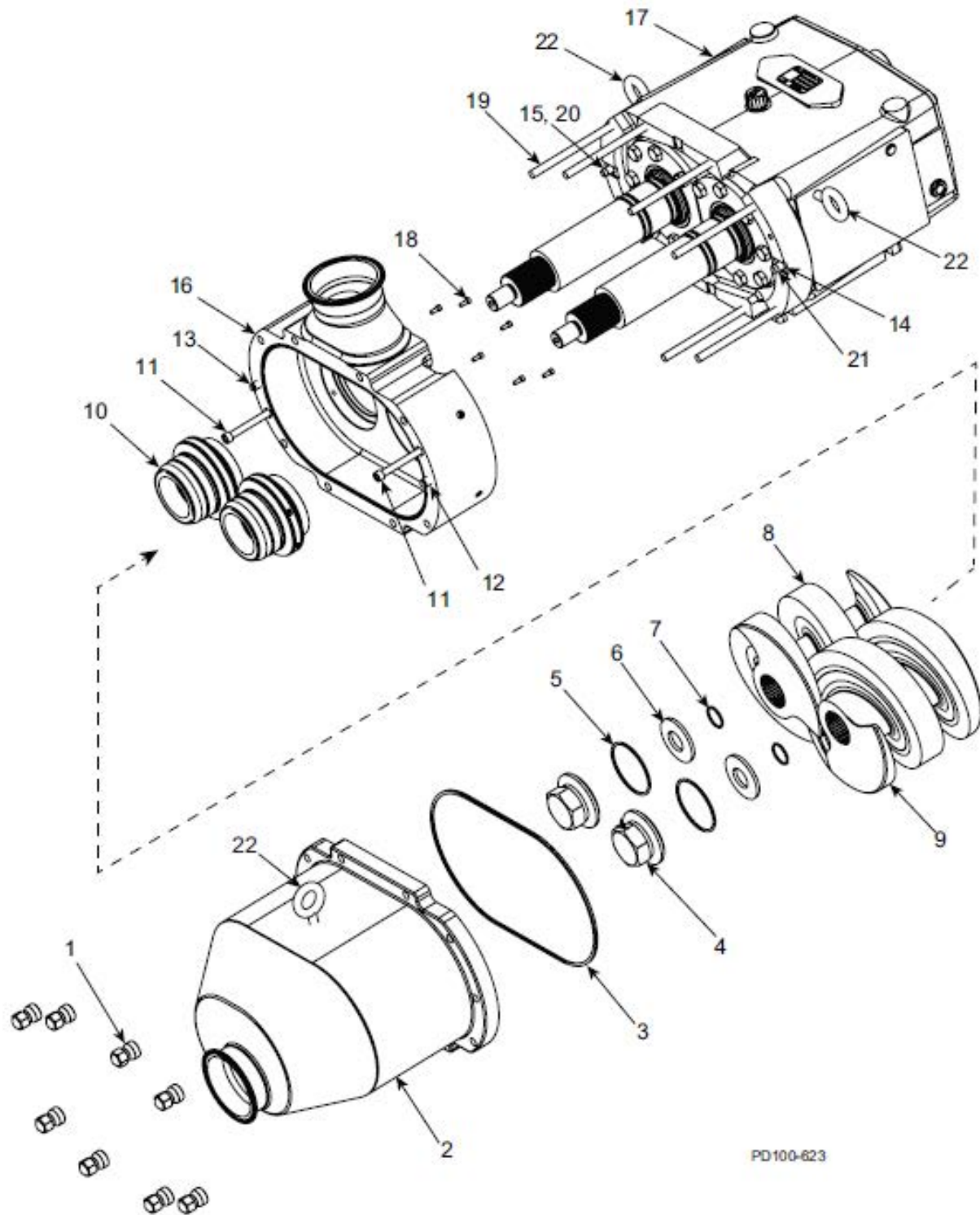

PD100-623

220-UTS Parts

ITEM NO	DESCRIPTION	QTY PER PUMP	PART NO.	NOTES
1	Nut, Acorn	8	108372+	
2	Cover	1	POA	
3	Gasket, Cover, EPDM	1	137433+	
	Gasket, Cover, FKM		12 137431+	
	Gasket, Cover, FFKM		137432+	
4	Nut, Screw	2	137608+	
5	Screw Nut O-ring EPDM	2	E70235	
	Screw Nut O-ring FKM		V70235	
	Screw Nut O-ring FFKM		K70235	
6	Washer-Belleville	2	101694+	
7	Washer Retainer O-ring EPDM	2	E70122	
	Washer Retainer O-ring FKM		V70122	
	Washer Retainer O-ring FFKM		K70122	
8	Left Hand Screw - 45 Pitch	1	137375+	
	Left Hand Screw - 60 Pitch		136801+	
	Left Hand Screw - 90 Pitch		137377+	
9	Right Hand Screw - 45 Pitch	1	137374+	
	Right Hand Screw - 60 Pitch		136800+	
	Right Hand Screw - 90 Pitch		137376+	
10	Mechanical Seal Assembly	2	POA	1
11	Body Retaining Screw	2	137099+	
12	Cover Short Dowel Pin	1	137005+	
13	Cover Short Dowel Pin	1	137004+	
14	Bushing, Dowel Pin	1	CD0116100	
15	Bushing, Dowel Pin	1	CD0116000	
16	Pump Body	1	POA	
17	Gear Case Assy	1	POA	
18	SHCS 10-32x.50 18-8 SS	6	30-243	
19	Stud, Standard Cover	8	108844+	
20	Gear Case Dowel	1	124584+	
21	Gear Case Dowel	1	124586+	
22	Eye Bolt 1/2-13 x .75 304SS	3	30-721	

Notes:

* Recommended Spare Part

1. See "Universal Twin Screw Seal Parts" on page 152.
 2. On the 220-UTS, this gasket is installed in the body, not the cover.
- POA: Contact customer service for part number.



220-UTS Parts, continued

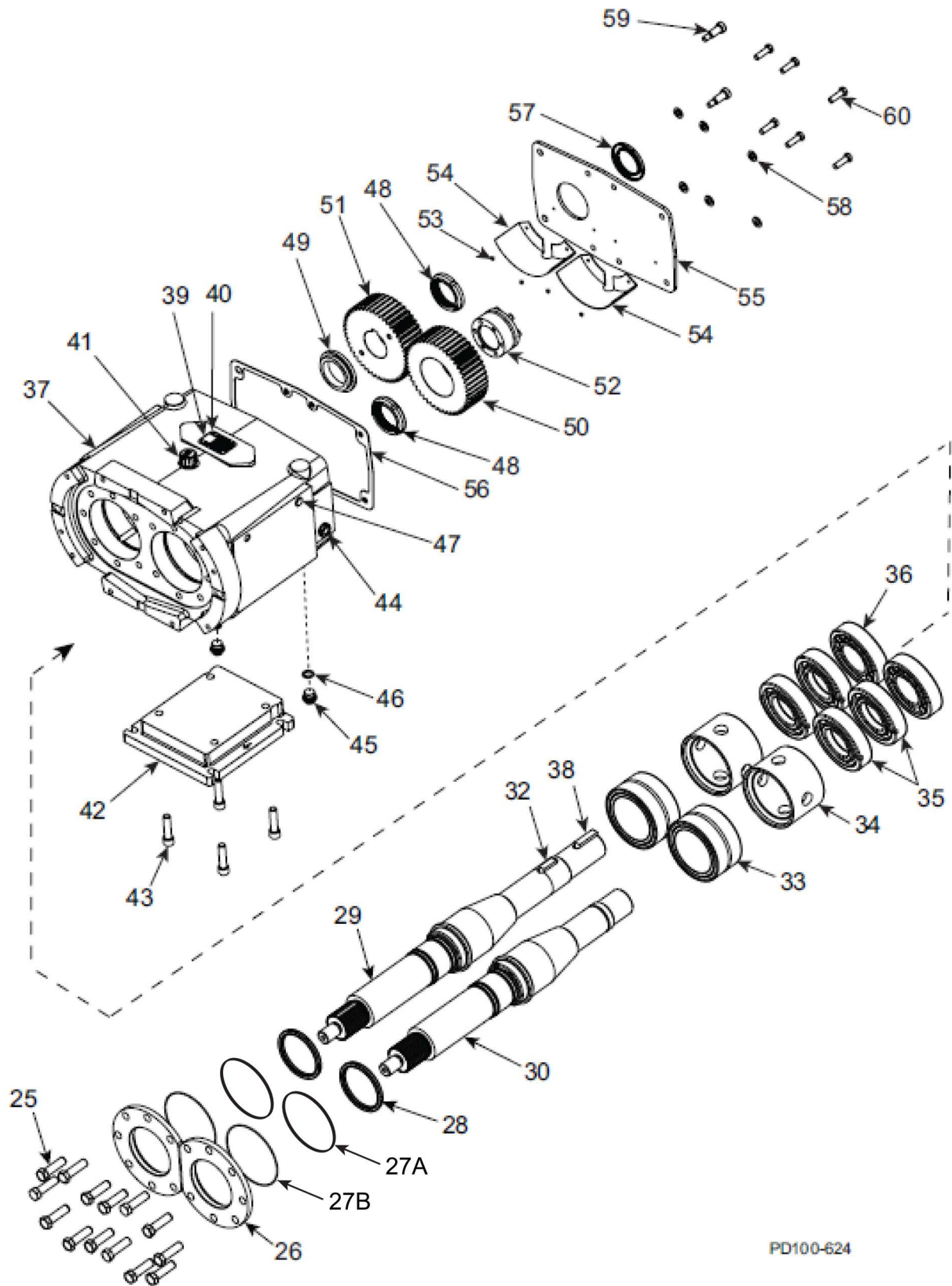

PD100-624

220-UTS Parts, continued

ITEM NO	DESCRIPTION	QTY PER PUMP	PART NO.	NOTES
25	HHCS 9/16-12 X 2.00 18-8 SS	14	30-731	
26	Bearing Retainer	2	137545+	
27A	Bearing Retainer O-Ring 1	2	304498+	
27B	Bearing Retainer O-Ring 2	2	138859+	
28	Seal, Bearing	2	121681+	
29	Shaft-Drive 17-4 PH	1	136832+	
30	Shaft-Short 17-4 PH	1	136833+	
32	Gear Key	1	200037000+	
33	Needle Roller Bearing	2	137553+	
34	Spacer, Bearing	2	137549+	
35	Four Point Angular Contact Brg.	4	137557+	
36	Cylindrical Roller Brg.	2	137561+	
37	Gear Case - Stainless Stl.	1	136844+	
38	Key .500 x .500 x 1.875	1	000037004+	
39	Nameplate - QR Code	1	135624+	
40	RHDS #2 x .125	4	30-355	
41	Breather Plug-Oil	1	139779+	
42	Gear Case Shim, SS (Mounting Foot)	1	140086+	
43	SHCS 1/2-13 x 2.0" 18-8	4	30-44	
44	Oil Sight Glass	1	137435+	
45	Plug-Drain/Level M20x1.5	2	137169+	1
46	O-Ring Buna	2	N70114	
47	Plug 1/2" Plastic	2	000121001+	
48	Locking Nut	2	137569+	
49	Spacer-Gear	1	138981+	
50	Gear, Short Shaft, Spur	1	112105+	
51	Gear, Drive Shaft, Spur	1	110932+	
52	Locking Assembly	1	108786+	
53	BHSC Screw 6-32UNC .188 18-8 SS	4	139887+	
54	Shroud, Gear	2	139148+	
55	Cover, Gear Case	1	139001+	
56	Gasket, Gear Case/Cover	1	138522+	
57	Oil Seal, Gear Case Cover	1	STD030006	
58	Washer Plain 3/8 18-8 Narrow	6	43-30	
59	SHSB 1/2" X 1.0" 18-8	2	30-692	
60	HHCS 3/8-16 X .75 18-8 SS	6	30-50	

Notes:

* Recommended Spare Parts

2. Pumps shipped prior to February 2018 used the shorter mounting foot, 102287+.



030-UTS Pump Body-Centre, 3 Piece Parts

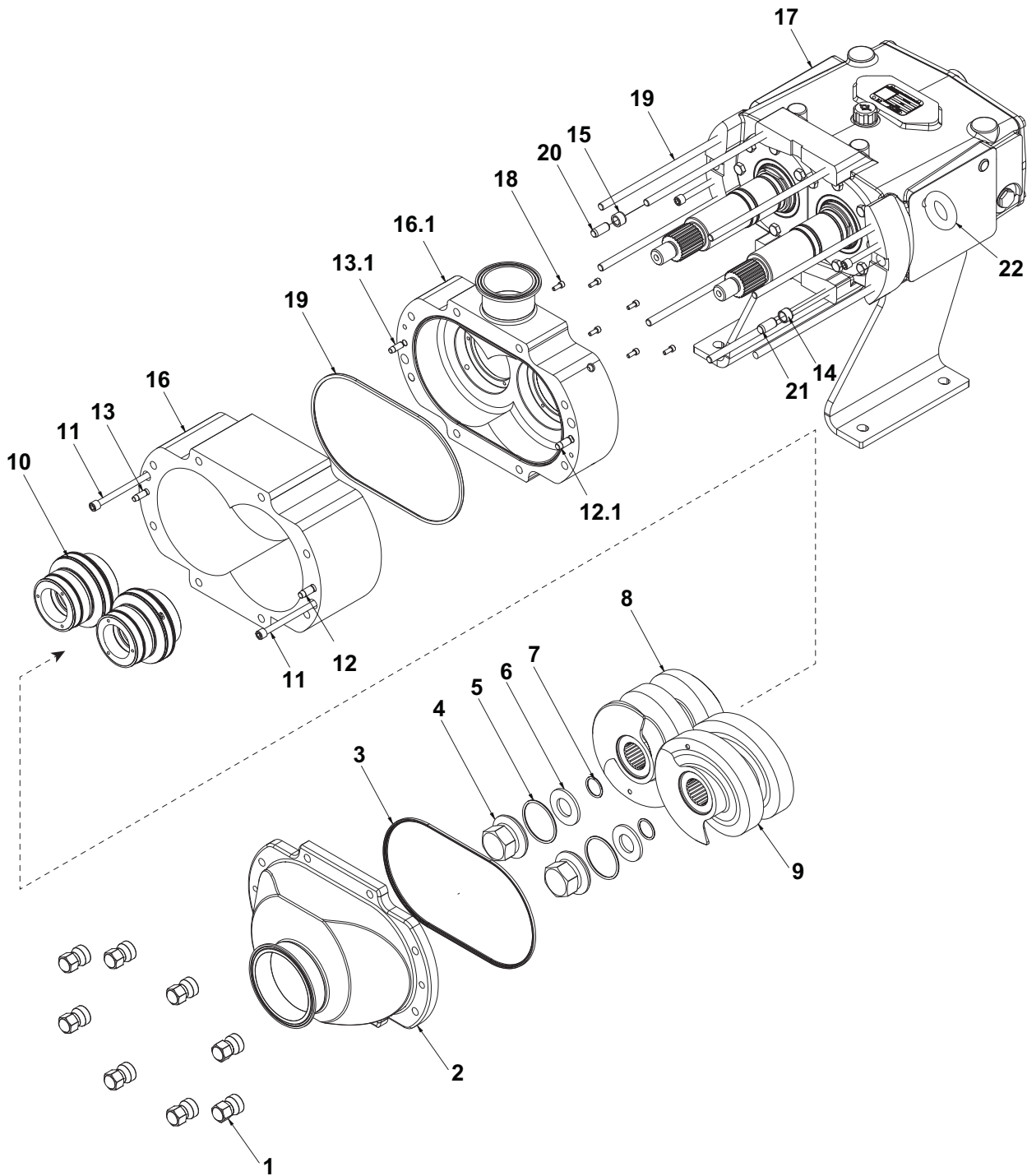

030-UTS Pump Body-Centre, 3 Piece Parts

ITEM NO	DESCRIPTION	QTY PER PUMP	PART NO.	NOTES
1	Nut, Acorn	8	108370+	
2	Cover	1	POA	
*	Gasket, Cover, EPDM	1	137427+	
	Gasket, Cover, FKM		137425+	
	Gasket, Cover, FFKM		137426+	
4	Nut, Screw	2	101805+	
*	Screw Nut O-ring EPDM	2	E70130	
	Screw Nut O-ring FKM		V70130	
	Screw Nut O-ring FFKM		K70130	
6	Washer-Belleville	2	101692+	
*	Washer Retainer O-ring EPDM	2	E70115	
	Washer Retainer O-ring FKM		V70115	
	Washer Retainer O-ring FFKM		K70115	
8	Left Hand Screw - 45 Pitch	1	137367+	
	Left Hand Screw - 60 Pitch		136795+	
	Left Hand Screw - 90 Pitch		137369+	
9	Right Hand Screw - 45 Pitch	1	137366+	
	Right Hand Screw - 60 Pitch		136794+	
	Right Hand Screw - 90 Pitch		137368+	
10	Mechanical Seal Assembly	2	POA	1
11	Body Retaining Screw	2	137097+	
12	Cover Short Dowel Pin	1	137002+	
12.1	Short Dowel Pin	1	137002+	
13	Cover Short Dowel Pin	1	137004+	
13.1	Short Dowel Pin	1	137001+	
14	Bushing, Dowel Pin	1	BD0116100	
15	Bushing, Dowel Pin	1	BD0116000	
16	Pump Body, Rotor side	1	POA	
16.1	Pump Body, Port side	1	POA	
17	Gear Case Assy	1	POA	
18	SHCS 10-32x.50 18-8 SS	6	137460+	
19	Stud, Standard Cover	8	137069+	
20	Gear Case Dowel	1	124582+	
21	Gear Case Dowel	1	124583+	
22	Eye Bolt 1/2-13 x .75 304SS	2	30-720	

NOTE:

* Recommended spare part

1. See "Universal Twin Screw Seal Parts" on page 152.

POA: Contact customer service for part number.



030-UTS PLUS Parts, continued

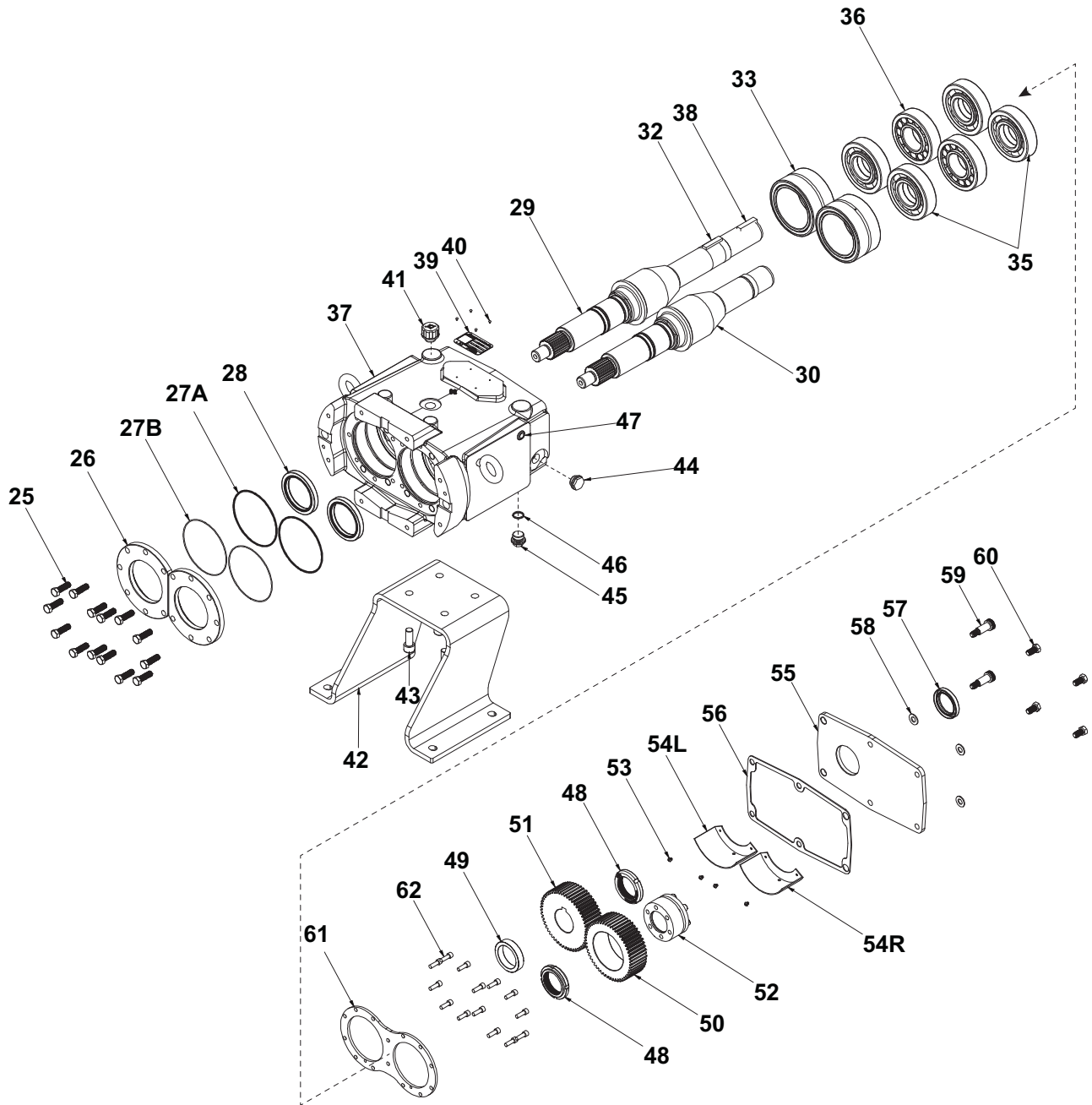

030-UTS PLUS Parts, continued

ITEM NO	DESCRIPTION	QTY PER PUMP	PART NO.	NOTES
25	HHCS 5/16-18 X .75 LG SS 304	14	30-623	
26	Front Bearing Retainer	2	142392+	
27A	Bearing Retainer O-Ring 1	2	304496+	
27B	Bearing Retainer O-Ring 2	2	138857+	
28	Seal, Bearing	2	121680+	
29	Shaft-Drive 17-4 PH	1	142399+	
30	Shaft-Short 17-4 PH	1	142400+	
32	Gear Key	1	BD0037000	
33	Needle Roller Bearing	2	142401+	
35	Four Point Angular Contact Brg.	4	137555+	
36	Cylindrical Roller Brg.	2	137559+	
37	Gear Case - Stainless Stl.	1	142387+	
38	Key, .250 x .250 x 1.750	1	000037002+	
39	Nameplate - QR Code	1	7403949	
40	RHDS #2 x 0.125	4	30-355	
41	Breather Plug-Oil	1	139779+	
42	Gear Case Shim, SS (Mounting Foot)	1	140084+	2
43	SHCS 3/8-16x1.00 18-8 SS	4	140435+	
44	Oil Sight Glass - SS	1	115799+	
45	Plug-Drain/Level M20x1.5	2	137169+	
* 46	O-Ring Buna	1	N70114	
47	Plug 3/8" Plastic	2	000121002+	
48	Locking Nut	2	137567+	
49	Spacer-Gear	1	030055000+	
50	Gear, Short Shaft, Spur	1	108000+	
51	Gear, Drive Shaft, Spur	1	107999+	
52	Locking Assembly	1	108784+	
53	BHSC Screw 6-32UNC.188 18-8 SS	4	139887+	
54	Shroud, Gear	2	139141+	
55	Cover, Gear Case	1	139137+	
56	Gasket, Gear Case/Cover	1	138520+	
57	Oil Seal, Gear Case Cover	1	000030013+	
58	Washer Plain 3/8 18-8 Narrow	4	43-30	
59	SHSB 1/2" X 1.0" 18-8	2	30-691	
60	HHCS 5/16-18 X.75" LG 304	4	30-623	
61	Rear Bearing Retainer	1	142393+	
62	SHCS 8-32 X .500	14	142402+	

NOTE: * Recommended Spare Parts

130-UTS Pump Body-Centre, 3 Piece Parts

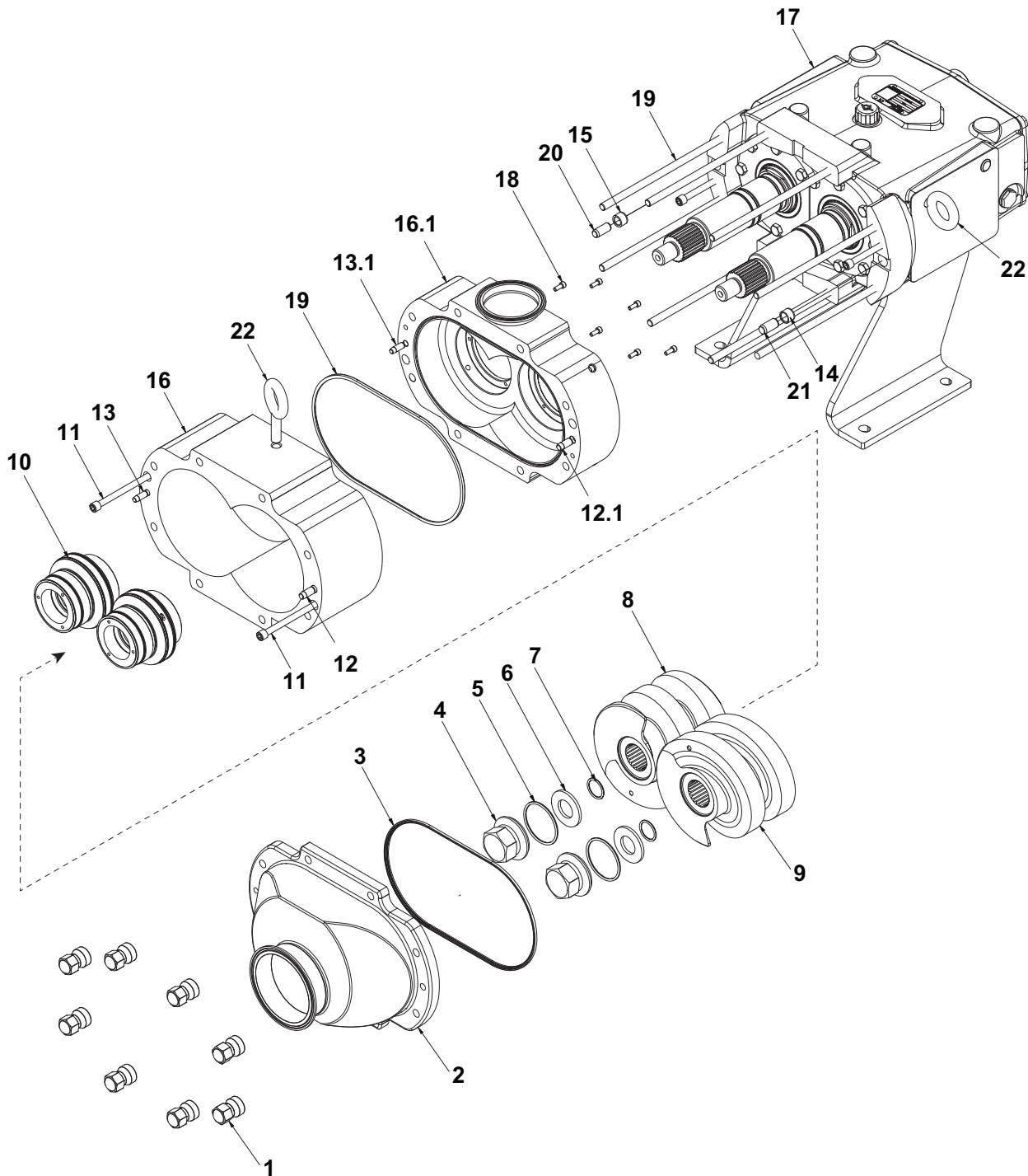

130-UTS Pump Body-Centre, 3 Piece Parts

ITEM NO	DESCRIPTION	QTY PER PUMP	PART NO.	NOTES
1	Nut, Acorn	8	108371+	
2	Cover	1	POA	
*	Gasket, Cover, EPDM	1	137430+	
	Gasket, Cover, FKM		137428+	
	Gasket, Cover, FFKM		137429+	
4	Nut, Screw	2	101806+	
*	Screw Nut O-ring EPDM	2	E70227	
	Screw Nut O-ring FKM		V70227	
	Screw Nut O-ring FFKM		K70227	
6	Washer-Belleville	2	101693+	
*	Washer Retainer O-ring EPDM	2	E70119	
	Washer Retainer O-ring FKM		V70119	
	Washer Retainer O-ring FFKM		K70119	
8	Left Hand Screw - 36.7 Pitch	1	137371+	
	Left Hand Screw - 55 Pitch		136798+	
	Left Hand Screw - 73.4 Pitch		137373+	
9	Right Hand Screw - 36.7 Pitch	1	137370+	
	Right Hand Screw - 55 Pitch		136797+	
	Right Hand Screw - 73.4 Pitch		137372+	
10	Mechanical Seal Assembly	2	POA	1
11	Body Retaining Screw	2	132089+	
12	Cover Short Dowel Pin	1	137003+	
12.1	Short Dowel Pin	1	137003+	
13	Cover Short Dowel Pin	1	137002+	
13.1	Short Dowel Pin	1	137002+	
14	Bushing, Dowel Pin	1	CD0116100	
15	Bushing, Dowel Pin	1	CD0116000	
16	Pump Body, Rotor side	1	POA	
16.1	Pump Body, Port side	1	POA	
17	Gear Case Assy	1	POA	
18	SHCS 10-32x.50 18-8 SS	6	30-243	
19	Stud, Standard Cover	8	137070+	
20	Gear Case Dowel	1	124584+	
21	Gear Case Dowel	1	124586+	
22	Eye Bolt 1/2-13 X .75"LG 304	3	30-721	

NOTE:

* Recommended spare part

1. See "Universal Twin Screw Seal Parts" on page 152.

POA: Contact customer service for part number.



130-UTS PLUS Parts, continued

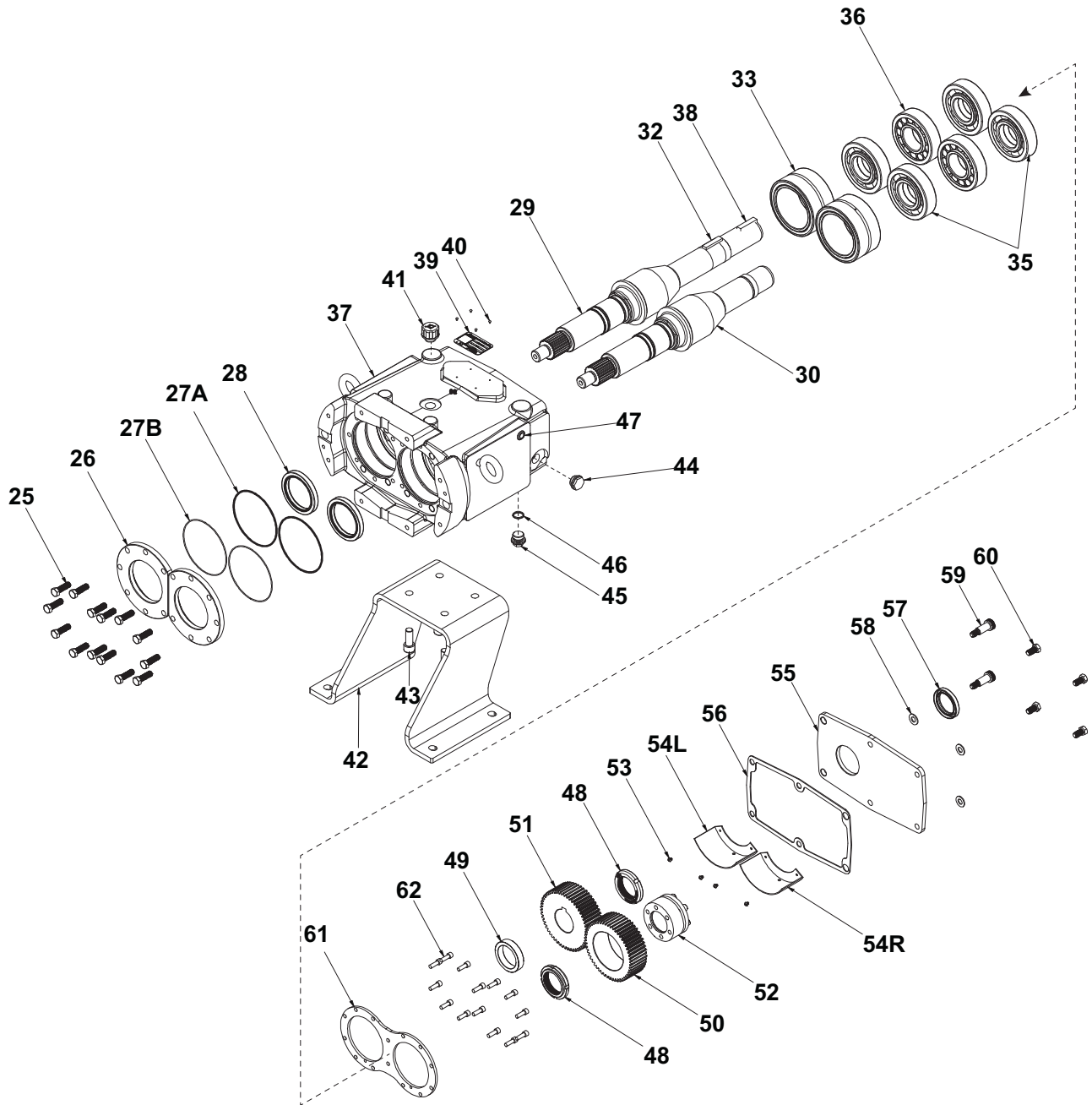

130-UTS PLUS Parts, continued

ITEM NO	DESCRIPTION	QTY PER PUMP	PART NO.	NOTES
25	HHCS 3/8-16 X 1.25 18-8 SS	14	30-60	
26	Front Bearing Retainer	2	142241+	
27A	Bearing Retainer O-Ring 1	2	304497+	
27B	Bearing Retainer O-Ring 2	2	138858+	
28	Seal, Bearing	2	101829+	
29	Shaft-Drive 17-4 PH	1	136830+	
30	Shaft-Short 17-4 PH	1	136831+	
32	Gear Key	1	060037000+	
33	Needle Roller Bearing	2	137552+	
35	Four Point Angular Contact Brg.	4	137556+x	
36	Cylindrical Roller Brg.	2	137560+	
37	Gear Case - Stainless Stl.	1	142236+	
38	Key 375 x 0.375 x 1.625	1	000037003+	
39	Nameplate - QR Code	1	7403951+	
40	RHDS #2 x 0.125	4	30-355	
41	Breather Plug-Oil	1	139779+	
42	Gear Case Shim, SS (Mounting Foot)	1	140085+	2
43	SHCS 1/2-13x1.25"LG 18-8	4	30-503	
44	Oil Sight Glass - SS	1	115799+	
45	Plug-Drain/Level M20x1.5	2	137169+	
* 46	O-Ring Buna	1	N70114	
47	Plug 1/2" Plastic	2	000121001+	
48	Locking Nut	2	137568+	
49	Spacer-Gear	1	138980+	
50	Gear, Short Shaft, Spur	1	107405+	
51	Gear, Drive Shaft, Spur	1	138508+	
52	Locking Assembly	1	108785+	
53	BHSC Screw 6-32UNC.188 18-8 SS	4	139887+	
54	Shroud, Gear	2	139147+	
55	Cover, Gear Case	1	139139+	
56	Gasket, Gear Case/Cover	1	138521+	
57	Oil Seal, Gear Case Cover	1	000030012+	
58	Washer Plain 3/8 18-8 Narrow	4	43-30	
59	SHSB 1/2" X 1.0" 18-8	2	30-692	
60	HHCS 3/8-16 x 0.75" 18-8	4	30-50	
61	Rear Bearing Retainer	1	142242+	
62	SHCS 1/4-20 X .750"	14	142405+	

NOTE: * Recommended Spare Parts

Universal Twin Screw Seal Parts

Items in a Double Mechanical Seal

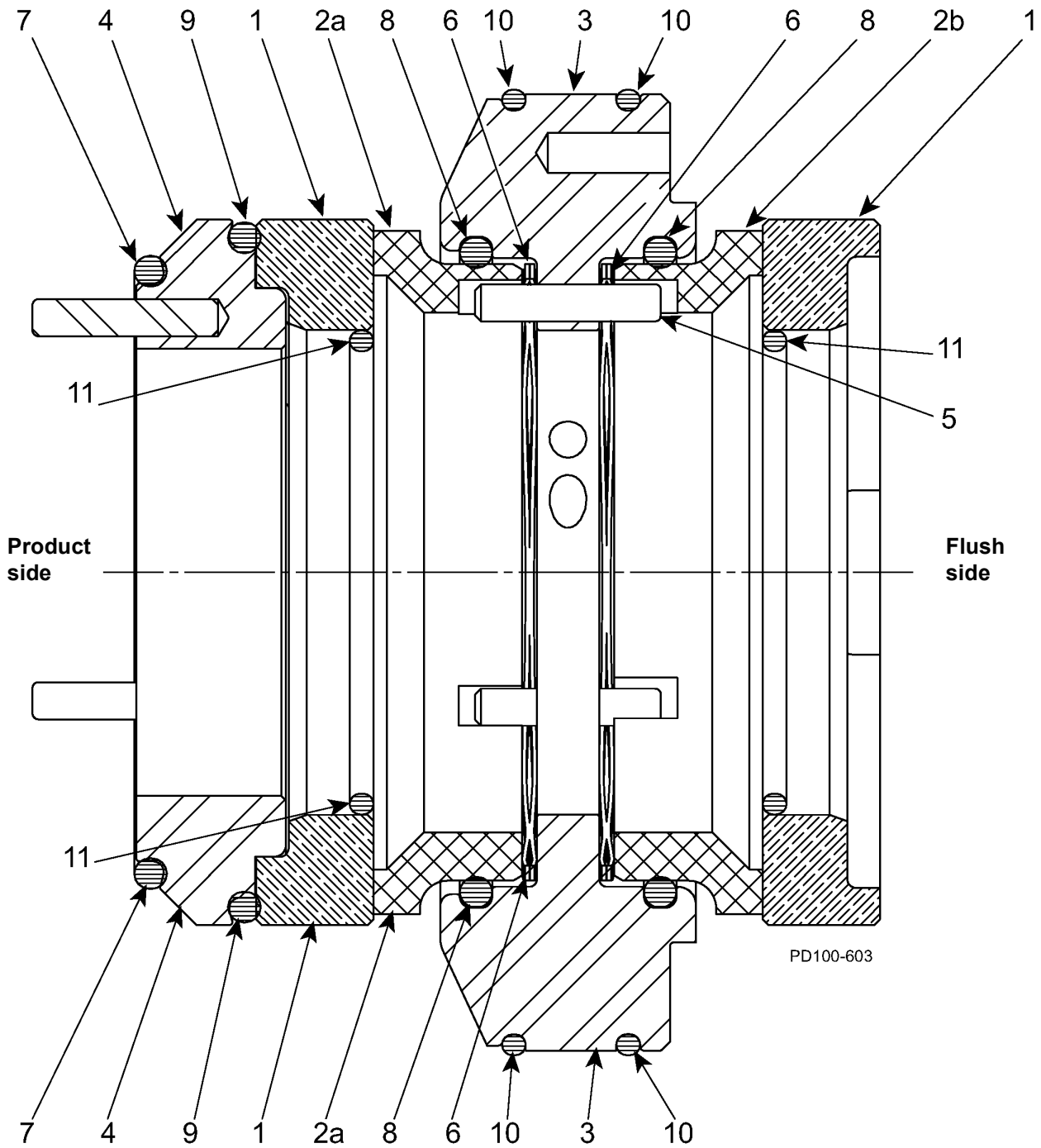

Items in a Single Mechanical Seal

Universal Twin Screw Seal Parts

Item No.	Description		Part Number				Qty. Per Pump	
			015-UTS	030-UTS	130-UTS	220-UTS	Double Mach. Seal	Single Mach. Seal
1	Seat, Seal	SC	137104+	124745+	124747+	137106+		
		TC	137105+	124746+	124748+	137107+	4	2
2a	Seal, Product side	C	137053+	137054+	137055+	137056+		
		SC	137109+	137111+	137113+	137115+		
		TC	137110+	137112+	137114+	137116+	2	2
2b	Seal, Flush side	C	137053+	137054+	137055+	137056+	2	n/a
3	Seal Carrier		137057+	137058+	137059+	137060+	2	2
4	Seal Cap Assembly		141541+	141542+	141543+	141544+	2	2
5	Pin, Stop		137076+	137077+	137078+	137079+	6	6
6	Seal Wave Spring		137015+	137016+	137017+	137018+	4	2
7	O-ring- Cap to Screw	EPDM	E70129	E70135	E70147	E70152		
		FKM	V70129	V70135	V70147	V70152		
		FFKM	K70129	K70135	K70147	K70152	2	2
8	O-ring- Carrier to Seal	EPDM	E70131	E70137	E70146	E70153		
		FKM	V70131	V70137	V70146-680	V70153		
		FFKM	K70131	K70137	K70146	K70153	4	2
9	O-ring- Cap to Seat	EPDM	E70131	E70138	E70147	E70153		
		FKM	V70131	V70138	V70147	V70153		
		FFKM	K70131	K70138	K70147	K70153	2	2
10	O-ring- Carrier to Body	EPDM	E70036	E70041	E70154	E70158		
		FKM	V70036	V70041	V70154	V70158		
		FFKM	K70036	K70041	K70154	K70158	4	4
11	O-ring- Shaft	EPDM	E70024	E70029	E70133	E70145		
		FKM	V70024	V70029	V70133	V70145		
		FFKM	K70024	K70029	K70133	K70145	4	2

Note:

* Recommended Spare Parts

- Quantities listed are per pump. There are two seal assemblies on each pump.
- The cross-sectional view on page 151 is of a double mechanical seal. Components of a single mechanical seal are called out in the bottom half of that image.



Universal Twin Screw Seal Kits

015-UTS	Part#
SEAL KIT, 015UTS, SM, C/SC, EPDM	140251+
SEAL KIT, 015UTS, SM, C/SC, FKM	140252+
SEAL KIT, 015UTS, SM, C/SC, FFKM	140253+
SEAL KIT, 015UTS, SM, SC/SC, EPDM	140254+
SEAL KIT, 015UTS, SM, SC/SC, FKM	140255+
SEAL KIT, 015UTS, SM, SC/SC, FFKM	140256+
SEAL KIT, 015UTS, SM, TC/SC, EPDM	140257+
SEAL KIT, 015UTS, SM, TC/SC, FKM	140258+
SEAL KIT, 015UTS, SM, TC/SC, FFKM	140259+
SEAL KIT, 015UTS, SM, TC/TC, EPDM	140260+
SEAL KIT, 015UTS, SM, TC/TC, FKM	140261+
SEAL KIT, 015UTS, SM, TC/TC, FFKM	140262+
SEAL KIT, 015UTS, DM, C/SC-C/SC, EPDM	140263+
SEAL KIT, 015UTS, DM, C/SC-C/SC, FKM	140264+
SEAL KIT, 015UTS, DM, C/SC-C/SC, FFKM	140265+
SEAL KIT, 015UTS, DM, SC/SC-C/SC, EPDM	140266+
SEAL KIT, 015UTS, DM, SC/SC-C/SC, FKM	140267+
SEAL KIT, 015UTS, DM, SC/SC-C/SC, FFKM	140268+
SEAL KIT, 015UTS, DM, TC/SC-C/SC, EPDM	140269+
SEAL KIT, 015UTS, DM, TC/SC-C/SC, FKM	140270+
SEAL KIT, 015UTS, DM, TC/SC-C/SC, FFKM	140271+
SEAL KIT, 015UTS, DM, TC/TC-C/SC, EPDM	140272+
SEAL KIT, 015UTS, DM, TC/TC-C/SC, FKM	140273+
SEAL KIT, 015UTS, DM, TC/TC-C/SC, FFKM	140274+

030-UTS	Part#
SEAL KIT, 030UTS, SM, C/SC, EPDM	140275+
SEAL KIT, 030UTS, SM, C/SC, FKM	140307+
SEAL KIT, 030UTS, SM, C/SC, FFKM	140277+
SEAL KIT, 030UTS, SM, SC/SC, EPDM	140278+
SEAL KIT, 030UTS, SM, SC/SC, FKM	140279+
SEAL KIT, 030UTS, SM, SC/SC, FFKM	140280+
SEAL KIT, 030UTS, SM, TC/SC, EPDM	140281+
SEAL KIT, 030UTS, SM, TC/SC, FKM	140282+
SEAL KIT, 030UTS, SM, TC/SC, FFKM	140283+
SEAL KIT, 030UTS, SM, TC/TC, EPDM	140284+
SEAL KIT, 030UTS, SM, TC/TC, FKM	140285+
SEAL KIT, 030UTS, SM, TC/TC, FFKM	140286+
SEAL KIT, 030UTS, DM, C/SC-C/SC, EPDM	140306+
SEAL KIT, 030UTS, DM, C/SC-C/SC, FKM	140276+
SEAL KIT, 030UTS, DM, C/SC-C/SC, FFKM	140308+
SEAL KIT, 030UTS, DM, SC/SC-C/SC, EPDM	140309+
SEAL KIT, 030UTS, DM, SC/SC-C/SC, FKM	140310+
SEAL KIT, 030UTS, DM, SC/SC-C/SC, FFKM	140311+
SEAL KIT, 030UTS, DM, TC/SC-C/SC, EPDM	140312+
SEAL KIT, 030UTS, DM, TC/SC-C/SC, FKM	140313+
SEAL KIT, 030UTS, DM, TC/SC-C/SC, FFKM	140314+
SEAL KIT, 030UTS, DM, TC/TC-C/SC, EPDM	140315+
SEAL KIT, 030UTS, DM, TC/TC-C/SC, FKM	139695+
SEAL KIT, 030UTS, DM, TC/TC-C/SC, FFKM	140317+

130-UTS	Part#
SEAL KIT, 130UTS, SM, C/SC, EPDM	140318+
SEAL KIT, 130UTS, SM, C/SC, FKM	140319+
SEAL KIT, 130UTS, SM, C/SC, FFKM	140320+
SEAL KIT, 130UTS, SM, SC/SC, EPDM	140321+
SEAL KIT, 130UTS, SM, SC/SC, FKM	140322+
SEAL KIT, 130UTS, SM, SC/SC, FFKM	140323+
SEAL KIT, 130UTS, SM, TC/SC, EPDM	140324+
SEAL KIT, 130UTS, SM, TC/SC, FKM	140325+
SEAL KIT, 130UTS, SM, TC/SC, FFKM	140326+
SEAL KIT, 130UTS, SM, TC/TC, EPDM	140327+
SEAL KIT, 130UTS, SM, TC/TC, FKM	140328+
SEAL KIT, 130UTS, SM, TC/TC, FFKM	140329+
SEAL KIT, 130UTS, DM, C/SC-C/SC, EPDM	140330+
SEAL KIT, 130UTS, DM, C/SC-C/SC, FKM	140331+
SEAL KIT, 130UTS, DM, C/SC-C/SC, FFKM	140332+
SEAL KIT, 130UTS, DM, SC/SC-C/SC, EPDM	140333+
SEAL KIT, 130UTS, DM, SC/SC-C/SC, FKM	140334+
SEAL KIT, 130UTS, DM, SC/SC-C/SC, FFKM	140335+
SEAL KIT, 130UTS, DM, TC/SC-C/SC, EPDM	140336+
SEAL KIT, 130UTS, DM, TC/SC-C/SC, FKM	140337+
SEAL KIT, 130UTS, DM, TC/SC-C/SC, FFKM	140338+
SEAL KIT, 130UTS, DM, TC/TC-C/SC, EPDM	140339+
SEAL KIT, 130UTS, DM, TC/TC-C/SC, FKM	140340+
SEAL KIT, 130UTS, DM, TC/TC-C/SC, FFKM	140341+

220-UTS	Part#
SEAL KIT, 220UTS, SM, C/SC, EPDM	140342+
SEAL KIT, 220UTS, SM, C/SC, FKM	140343+
SEAL KIT, 220UTS, SM, C/SC, FFKM	140344+
SEAL KIT, 220UTS, SM, SC/SC, EPDM	140345+
SEAL KIT, 220UTS, SM, SC/SC, FKM	140346+
SEAL KIT, 220UTS, SM, SC/SC, FFKM	140347+
SEAL KIT, 220UTS, SM, TC/SC, EPDM	140348+
SEAL KIT, 220UTS, SM, TC/SC, FKM	140349+
SEAL KIT, 220UTS, SM, TC/SC, FFKM	140350+
SEAL KIT, 220UTS, SM, TC/TC, EPDM	140351+
SEAL KIT, 220UTS, SM, TC/TC, FKM	140352+
SEAL KIT, 220UTS, SM, TC/TC, FFKM	140353+
SEAL KIT, 220UTS, DM, C/SC-C/SC, EPDM	140354+
SEAL KIT, 220UTS, DM, C/SC-C/SC, FKM	140355+
SEAL KIT, 220UTS, DM, C/SC-C/SC, FFKM	140356+
SEAL KIT, 220UTS, DM, SC/SC-C/SC, EPDM	140357+
SEAL KIT, 220UTS, DM, SC/SC-C/SC, FKM	140358+
SEAL KIT, 220UTS, DM, SC/SC-C/SC, FFKM	140359+
SEAL KIT, 220UTS, DM, TC/SC-C/SC, EPDM	140360+
SEAL KIT, 220UTS, DM, TC/SC-C/SC, FKM	140361+
SEAL KIT, 220UTS, DM, TC/SC-C/SC, FFKM	140362+
SEAL KIT, 220UTS, DM, TC/TC-C/SC, EPDM	140363+
SEAL KIT, 220UTS, DM, TC/TC-C/SC, FKM	140364+
SEAL KIT, 220UTS, DM, TC/TC-C/SC, FFKM	140365+

Seal Kits key: SM: Single Mechanical, DM: Double Mechanical, C: Carbon, SC: Silicon Carbide, TC: Tungsten Carbide
 Kits include seals for both shafts, SM item nos. 1, 2a, 6, 7, 8, 9, 10, 11; DM item nos. 1, 2a, 2b, 6, 7, 8, 9, 10, 11



Special Tools

Non-Marring Socket Tool for Screw Nuts

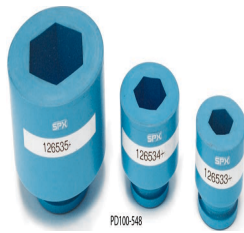

Pump Model	Part Number
015-UTS	126533+
030-UTS	126534+
130-UTS	126257+
220-UTS	126535+

UTS Shaft Locking Tool

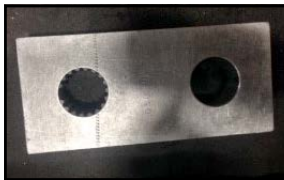

Pump Model	Part Number
015-UTS	139526+
030-UTS	139527+
130-UTS	139528+
220-UTS	139529+
	PL5060-CH151

O-ring Removal Tool

Description	Part Number
O-ring removal tool	AD0096001
	PL5060-CH130

Gear Tools

Description	Pump Model	Part Number
Gear Nut Driver	015-UTS	109281+
Gear Nut Driver	030-UTS	109282+
Gear Nut Driver	130-UTS	109283+
Gear Nut Driver	220-UTS	110304+

Gear End Shaft Thread Chaser	015-UTS	109287+
Gear End Shaft Thread Chaser	030-UTS	109288+
Gear End Shaft Thread Chaser	130-UTS	109289+
Gear End Shaft Thread Chaser	220-UTS	110305+

Screw Nut Tool

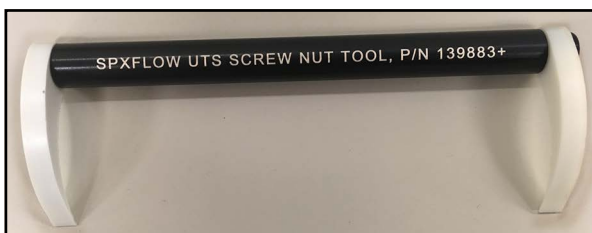

Description	Part number	Notes
Screw Nut Tool (pictured)	139883+	1
Screw Blocker, 220-UTS	139790+	2

Note:

- Do not apply to the 220-UTS
- The screw blocker for the 220-UTS is pictured in Figure 35 on page 34.

Universal Twin Screw Maintenance Summary Reference Sheet

Pump Model	Oil Capacity	Oil	Change oil
015-UTS	110 ml	Standard: Synthetic Mobil SHC 629-150, part no. 139215+ Food Grade: Synthetic Mobil SHC Cibus-150, part no. 139684+	250 hours, every 2000 hours thereafter*
030-UTS	216 ml		
130-UTS	525 ml		
220-UTS	1575 ml		

* Aggressive washdown or extreme running conditions may require more frequent intervals.

For more information, see "Lubrication" on page 28.

Pump Model	Torque Value		Wrench Size	
	Screw Nut	Cover Nut	Screw Nut	Cover Nut
015-UTS	30 ft-lb 41 N·m	7 ft-lb 10 N·m	15/16"	5/8"
030-UTS	55 ft-lb 68 N·m	11 ft-lb 15 N·m	1-1/4"	
130-UTS	120 ft-lb 163 N·m	25 ft-lb 34 N·m	1-5/8"	7/8"
220-UTS	275 ft-lb 373 N·m	55 ft-lb 75 N·m	2-1/4"	

Torque Values - Gear Case

Pump Model	Front Bearing Retainer Bolts	Locking Nut	Gear Case Cover Fasteners	
			HHCS	SHSB
015-UTS	24 in-lb (2 ft-lb) 3 N·m	75 ft-lb 102 N·m	88 in-lb 10 N·m	110 in-lb 12 N·m
030-UTS	84 in-lb (7 ft-lb) 9 N·m	100 ft-lb 136 N·m	110 in-lb 12 N·m	132 in-lb 15 N·m
130-UTS	180 in-lb (15 ft-lb) 20 N·m	140 ft-lb 190 N·m	132 in-lb 15 N·m	176 in-lb 20 N·m
220-UTS	300 in-lb (25 ft-lb) 34 N·m	230 ft-lb 312 N·m		

Torque Values - Gear Case

Pump Model	Rear Bearing Retainer Bolts Half Torque	Rear Bearing Retainer Bolts Full Torque	Torque Sequence	Locking Nut	Gear Case Cover Fasteners	
					HHCS	SHSB
030-UTS PLUS	10 in-lb (0.85 ft-lb) 1.13 N·m	20 in-lb (1.5 ft-lb) 2.25 N·m	1-14	100 ft-lb 136 N·m	110 in-lb 12 N·m	132 in-lb 15 N·m
130-UTS PLUS	40 in-lb (3.5 ft-lb) 4.6 N·m	75 in-lb (6 ft-lb) 8.5 N·m	1-14	140 ft-lb 190 N·m	132 in-lb 15 N·m	176 in-lb 20 N·m

Torque Values - Locking Assembly

Pump Model	Screw Hex Size	Qty.	Half Torque	Full Torque
015-UTS	5 mm	8	63 in-lb (7 N·m)	126 in-lb (14 N·m)
030-UTS	5 mm	6	79 in-lb (9 N·m)	158 in-lb (18 N·m)
130-UTS, 220-UTS	6 mm	6	189 in-lb (21 N·m)	378 in-lb (43 N·m)



Universal Twin Screw Maintenance Summary Reference Sheet - Copy for optional removal

Pump Model	Oil Capacity	Oil	Change oil
015-UTS	110 ml	Standard: Synthetic Mobil SHC 629-150, part no. 139215+	250 hours, every 2000 hours thereafter*
030-UTS	216 ml		
130-UTS	525 ml	Food Grade: Synthetic Mobil SHC Cibus-150, part no. 139684+	
220-UTS	1575 ml		

* Aggressive washdown or extreme running conditions may require more frequent intervals.

For more information, see "Lubrication" on page 28.

Pump Model	Torque Values		Wrench Size	
	Screw Nut	Cover Nut	Screw Nut	Cover Nut
015-UTS	30 ft-lb 41 N·m	7 ft-lb 10 N·m	15/16"	5/8"
030-UTS	55 ft-lb 68 N·m	11 ft-lb 15 N·m	1-1/4"	
130-UTS	120 ft-lb 163 N·m	25 ft-lb 34 N·m	1-5/8"	7/8"
220-UTS	275 ft-lb 373 N·m	55 ft-lb 75 N·m	2-1/4"	

Torque Values - Gear Case				
Pump Model	Front Bearing Retainer Bolts	Locking Nut	Gear Case Cover Fasteners	
			HHCS	SHSB
015-UTS	24 in-lb (2 ft-lb) 3 N·m	75 ft-lb 102 N·m	88 in-lb 10 N·m	110 in-lb 12 N·m
030-UTS	84 in-lb (7 ft-lb) 9 N·m	100 ft-lb 136 N·m	110 in-lb 12 N·m	132 in-lb 15 N·m
130-UTS	180 in-lb (15 ft-lb) 20 N·m	140 ft-lb 190 N·m	132 in-lb 15 N·m	176 in-lb 20 N·m
220-UTS	300 in-lb (25 ft-lb) 34 N·m	230 ft-lb 312 N·m		

Torque Values - Gear Case						
Pump Model	Rear Bearing Retainer Bolts Half Torque	Rear Bearing Retainer Bolts Full Torque	Torque Sequence	Locking Nut	Gear Case Cover Fasteners	
					HHCS	SHSB
030-UTS PLUS	10 in-lb (0.85 ft-lb) 1.13 N·m	20 in-lb (1.5 ft-lb) 2.25 N·m	1-14	100 ft-lb 136 N·m	110 in-lb 12 N·m	132 in-lb 15 N·m
130-UTS PLUS	40 in-lb (3.5 ft-lb) 4.6 N·m	75 in-lb (6 ft-lb) 8.5 N·m	1-14	140 ft-lb 190 N·m	132 in-lb 15 N·m	176 in-lb 20 N·m

Torque Values - Locking Assembly				
Pump Model	Screw Hex Size	Qty.	Half Torque	Full Torque
015-UTS	5 mm	8	63 in-lb (7 N·m)	126 in-lb (14 N·m)
030-UTS	5 mm	6	79 in-lb (9 N·m)	158 in-lb (18 N·m)
130-UTS, 220-UTS	6 mm	6	189 in-lb (21 N·m)	378 in-lb (43 N·m)



Notes



Universal TS Series

ROTARY POSITIVE DISPLACEMENT
TWIN SCREW PUMP

SPXFLOW[®]

SPX FLOW, Inc.

611 Sugar Creek Road

Delavan, WI 53115

P: (262) 728-1900 or (800) 252-5200

F: (262) 728-4904 or (800) 252-5012

E: wcb@spxflow.com

SPX FLOW, Inc. reserves the right to incorporate our latest design and material changes without notice or obligation.

Design features, materials of construction and dimensional data, as described in this bulletin, are provided for your information only and should not be relied upon unless confirmed in writing.

Please contact your local sales representative for product availability in your region. For more information visit www.spxflow.com.

The green ">" is a trademark of SPX FLOW, Inc.

ISSUED: 06/2023 - Original Manual

COPYRIGHT © 2022 SPX FLOW, Inc.



TRIPLEX
Sales Company

Triplex Sales Company | SPX FLOW / Waukesha Cherry-Burrell support | triplexsales.com | 847.839.8442